



Driver & Vehicle  
Standards  
Agency

# Individual Vehicle Approval (IVA) manual for vehicle category M1

(Passenger Vehicles)



Driver and Vehicle Standards Agency ©Crown copyright 2016.

You may re-use this information (not including logos) free of charge in any format or medium, under the terms of the Open Government Licence.

To view this licence, visit [www.nationalarchives.gov.uk/doc/open-government-licence/](http://www.nationalarchives.gov.uk/doc/open-government-licence/) or write to the Information Policy Team, The National Archives, Kew, London TW9 4DU, or email: [psi@nationalarchives.gsi.gov.uk](mailto:psi@nationalarchives.gsi.gov.uk)

Any enquiries regarding this publication should be sent to us at [enquiries@vosa.gov.uk](mailto:enquiries@vosa.gov.uk).

This document is also available from the DVSA section of GOV.UK website at <https://www.gov.uk/vehicle-approval/overview>

## Contents Page

Version Control	24 Rear Registration Lamps
Non-European and Other Acceptable Standards	25 Headlamps
IVA Manual with Basic Requirements	26 Front Fog Lamps
01 Noise	28 Rear Fog Lamps
02A Visual Emissions	29 Reversing Lamps
02B Metered Emissions	30 Parking Lamps
02C Diesel Emissions	31 Seat Belts
03A Fuel Tanks	32 Forward Vision
04 Rear Registration Plate Space	33 Identification of Controls
05 Steering Effort	34 Defrost / Demist
06 Door Latches and Hinges	35 Wash Wipe
07 Audible Warning	36 Heating Systems
08 Indirect Vision	37 Wheel Guards
09A Brake Systems	44 Masses and Dimensions
09B Service Brake Control / Mechanical Components	45 Safety Glass
09C Park Brake Control / Mechanical Components	46 Tyres
09D Hydraulic and Vacuum Systems	50 Couplings
09E Brake Performance	60 Frontal Protection System (Bull bar)
10 Electromagnetic Compatibility	69 Electric/Hybrid Vehicles
12 Interior Fittings	General Construction
13A Anti – Theft / Immobiliser	Normal IVA Requirements
13B Anti – Theft / Alarm	01 Noise
14 Protective Steering	02 Emissions
15 Seat Strength	09 Braking
16 Exterior Projections	13A Anti – Theft / Immobiliser
17 Speedometer and Reverse Gear	13B Anti – Theft / Alarm
18 Statutory Plates	14 Protective Steering
19 Seat Belt Anchorages	19 Seat Belt Anchorages
20 Installation of Lights	39 Fuel Consumption / CO2 Emissions
21 Retro Reflectors	53 Frontal Impact
22 End-outline, Position (Side), Stop, Side Marker & Daytime Running Lamps	54 Side Impact
23 Direction Indicators	62 Hydrogen Powered Motor Vehicles
	Glossary of Terms



## Version Control & Release Notes

Section Number	Section Title	Revision Date	Revision Number
-	Foreword	03/10/2016	10
-	Non-European and Other Acceptable Standards	03/10/2016	6
-	IVA Manual with Basic Requirements	27/03/2009	1
01	Noise	24/05/2010	2
02A	Visual Emissions	27/03/2009	1
02B	Metered Emissions	17/06/2013	7
02C	Diesel Emissions	03/10/2016	4
03A	Fuel Tanks	31/07/2009	2
04	Rear Registration Plate Space	09/04/2009	2
05	Steering Effort	17/06/2013	3
06	Door Latches and Hinges	17/06/2013	5
07	Audible Warning	31/07/2011	2
08	Indirect Vision	03/10/2016	6
09A	Brake Systems	24/05/2010	2
09B	Service Brake Control / Mechanical Components	24/05/2010	2
09C	Park Brake Control / Mechanical Components	31/10/2011	3
09D	Hydraulic and Vacuum Systems	24/05/2010	2
09E	Brake Performance	17/06/2013	4
10	Electromagnetic Compatibility	27/03/2009	1
12	Interior Fittings	03/10/2016	8
13A	Anti - Theft / Immobiliser	03/10/2016	6
13B	Anti - Theft / Alarm	17/06/2013	4
14	Protective Steering	24/05/2010	2
15	Seat Strength	17/06/2013	4
16	Exterior Projections	03/10/2016	8
17	Speedometer and Reverse Gear	03/10/2016	4
18	Statutory Plates	17/06/2013	10
19	Seat Belt Anchorages	17/06/2013	7
20	Installation of Lights	03/10/2016	8
21	Retro Reflectors	17/06/2013	4

22	End-outline, Position (Side), Stop, Side Marker & Daytime Running Lamps	17/06/2013	5
23	Direction Indicators	29/04/2012	2
24	Rear Registration Lamps	17/06/2013	3
25	Headlamps	03/10/2016	6
26	Front Fog Lamps	30/09/2012	5
28	Rear Fog Lamps	03/10/2016	9
29	Reversing Lamps	03/10/2016	3
30	Parking Lamps	03/10/2016	3
31	Seat Belts	03/10/2016	7
32	Forward Vision	17/06/2013	3
33	Identification of Controls	24/05/2010	2
34	Defrost / Demist	27/03/2009	1
35	Wash Wipe	27/03/2009	1
36	Heating Systems	03/10/2016	5
37	Wheel Guards	17/06/2013	4
44	Masses and Dimensions	03/10/2016	8
45	Safety Glass	03/10/2016	7
46	Tyres	17/06/2013	4
50	Couplings	24/05/2010	2
60	Frontal Protection System (Bull bar)	17/06/2013	2
69	Electric/Hybrid Vehicles	03/10/2016	1
-	General Construction	17/06/2013	3
-	Normal IVA Requirements	27/03/2009	1
01	Noise	17/06/2013	4
02	Emissions	03/10/2016	6
09	Braking	17/06/2013	3
13A	Anti – Theft / Immobiliser	03/10/2016	6
13B	Anti – Theft / Alarm	17/06/2013	6
14	Protective Steering	24/05/2010	2
19	Seat Belt Anchorages	30/09/2012	5
39	Fuel Consumption / CO2 Emissions	24/05/2010	2
53	Frontal Impact	24/05/2010	2
54	Side Impact	24/05/2010	2
62	Hydrogen Powered Motor Vehicles	03/10/2016	2
-	Glossary of Terms	03/10/2016	6

## Release Notes

### Version 10.00

Section Number	Section Title	MOI change	Required Standards	TSE Incorporated	Details
	Contents				Add section 69 Electric/Hybrid Vehicles
	Foreword				New second paragraph added page four, SPV Exemption Table updated
	Non European Standards				Update Section 19 (Other) from ADR 69/00 to ADR 73/00 Add Section 69
2C	Diesel Emissions	Yes	No		SPV notes from section 2B added
8	Indirect Vision	Yes	Yes		Incorporate camera systems, clarify Note 2 in Annexes 1 & 2.
12	Interior Fittings	Yes	No		SPV MOI expanded, Note added to Annex 1
13A	Anti-theft/Immobiliser	Yes	Yes	Yes	New Note 1 linked to RS4.
16	Exterior Projections	Yes	No		Hard feature relation to Shore A scale corrected, Note 5 para 4 expanded.
17	Speedometer and Reverse Gear	Yes	Yes	Yes	Update hyperlink, new Note 6 linked to RS3.
20	Installation of Lights	Yes	Yes	Yes	Update MOI and expand RS5
25	Headlamps	Yes	No	Yes	Add MOI re headlamp conversion

28	Rear Fog Lamps	Yes	Yes	Yes	Update Note 4, Amend max height. Reword RS4.
29	Reverse Lamps	Yes	No		Revise Table 1, max number of lamps
30	Parking Lamps	Yes	Yes		Insert new Notes 1 & 3 and renumber old Note 1 as Note 2. Link RS1 to Note 1 and RS2 to Notes 2 & 3
31	Seat Belts	Yes	Yes		Amend note reference in RS 10 & 12, remove references to Note 14, add Note reference to RS17.
36	Heating Systems	Yes	Yes		Renumber RS, update RS10, update Note 2.
44	Masses and Dimensions	No	No	Yes	MOI Axle weight calculations note expanded, Annex 1 B exemptions clarified
45	Safety Glass	No	No	Yes	Update Table 1, update definitions
69	Electric/Hybrid Vehicles	Yes	Yes		New Section (for information only)
N02	Emissions	Yes	No		Add paragraph to MOI for Range Extender Hybrids. Add Normal IVA to footer.
N13A	Anti-theft/Immobiliser	Yes	No		Expand MOI para 2. Add Normal IVA to footer.
N62	Hydrogen Powered Motor Vehicles	No	No		Add Normal IVA to footer.
	Glossary				Insert definition of Range Extender Hybrid

**Version 9.00**

Section Number	Section Title	MOI change Required Standards	TSE Incorporated	Details
----------------	---------------	-------------------------------	------------------	---------



	Contents				Insert Section 62 Hydrogen Powered vehicles
	Foreword				Reword paragraph 3 on page 3, remove paragraph k (transfer to Glossary) and reword bullet point 9 on page 8, Remove 2 <sup>nd</sup> line from header on page 11 and add reference to 'Run Lock' systems.
	Non European Standards				Update Section 2 (Other) ADR/Euro V, Insert ADR = Australian Design Standard
02B	Metered Emissions	Yes	No		Reword the second note on page 2 and exceptions (c) on page 6
05	Steering Effort	No	Yes		Correction to RS1
06	Door Latches and Hinges	Yes	No		Reword Mol paragraph 4, remove numbering from notes 1 & 2, reformat remainder of notes & insert definition of doors.
09E	Brake Performance	Yes	No		Revise notes numbering
12	Interior Fittings	Yes	Yes		Add WAV to Mol para 3, Insert new bold text in RS1, link extra notes to RS7 & 8, Insert new text in Annexes 1 & 3
13A	Anti-theft/Immobiliser	No	Yes		Correct typo in RS2
13B	Anti-theft/Alarm	Yes	No		Remove the word note
15	Seat Strength	Yes	No		Insert new sub paragraph (d) and remove numbering from note 4
16	Exterior Projections	Yes	No		Add text to labelling of Annex 2

17	Speedometer and Reverse Gear	Yes	No		Revise note 5
18	Statutory Plates	Yes	Yes		Reverse RS 4 & 5, Revise RS6, link RS5 to note 1 & RS7 to note12, revise RS8 – 14
19	Seat Belt Anchorages	Yes	No		Insert new paragraphs (c) & (d) in Mol, move Notes 1 & “to Annex 1 and remove note numbering from remainder.
20	Installation of Lights	Yes	Yes		Remove numbering from notes 1 – 8, amend note 2, insert new note 3, new paragraphs in Mol, add amber beacon to RS1 & 2 and new Figure 4.
21	Retro Reflectors	Yes	Yes		Remove note numbering, add the word ‘See’ to Table 1 in brackets (RS1, 2 & 4)
22	End-outline, Position (Side), Stop, Side Marker & Daytime Running Lamps	Yes	No		Amend Table 1 No. of Stop Lamps
24	Rear registration Plate Lamps	No	Yes		Link RS4 to note 1
28	Rear Fog Lamps	Yes	Yes		Insert new Note 4 and link to RS 3
29	Reversing Lamps	Yes	No		Add information regarding Scene Lamps
30	Parking Lamps	Yes	Yes		Insert Note 1 and link to RS2
31	Seat Belts	Yes	No		Insert new paragraph (c) on page 1, insert text in Fig.1, remove note 2, insert text in Annex 1, move note 4 to Annex 1
32	Forward Vision	No	Yes		Link RS1 to note 1
37	Wheel Guards	Yes	No		Amend wording in Mol paragraph 3

44	Masses and Dimensions	Yes	Yes		Remove numbering from notes 3 & 4, link RS10 to note 3, insert text in example 2 on page 6
45	Safety Glass	No	No		Reformat section
46	Tyres	No	No		Reformat RS2 and table numbers page 3
60	Frontal protection System	Yes	No		Remove numbering from note
	General Construction	No	Yes		Correction to RS2
N01	Noise	Yes	Yes		Link RS1 to notes 2 & 3, RS4 to note 1 and remove numbering from note 4.
N09	Braking	Yes	No		Remove the word note
N13A	Anti-Theft Immobiliser	Yes	No		Remove the word note
N13B	Anti-Theft Alarm	Yes	No		Remove the word note
	Glossary of Terms				Insert 4 definitions: Impossible to comply, Non rigid material, Run Lock and WAV

## Time bound concessions to required standards

Section Number	Section Title	End Date	Details	Notes
69	Electric/Hybrid vehicles	TBA	Section included for information only. DVSA will carry out a visual inspection only as per General Construction	

# Foreword

This Manual is a detailed guide on the inspection of vehicles submitted to an authorised testing station under the Individual Vehicle Approval (IVA) scheme.

It is produced for the examiners who carry out the inspections and for vehicle presenters and other interested parties who wish to familiarise themselves with the technical requirements and inspection procedures.

## Application

**The IVA scheme is one of three routes for a road vehicle to gain approval and thereby obtain licensing and registration in UK.**

The IVA route is open to vehicles falling under the following categories:

M1, M2, M3,  
N1, N2, N3  
O1, O2, O3, O4

This manual covers solely the IVA technical requirements for vehicles of the following categories:

M1 passenger vehicles with four or more wheels and not more than eight seats in addition to the driver's seat.

Determination of the number of seats in a vehicle is as follows; where a seat has no seat belt fitted each 400mm of seat base shall constitute a seat, where seat belts are fitted each seat space with a belt (providing the maximum anchorage separation requirements are not exceeded) is to constitute a seat and any remaining seat base measured to be 400mm or greater is to constitute a seat. All measurements are taken across the front of the seat cushion.

Determination of the number of wheelchair spaces is by either:

- a declaration from the manufacturer/convertor or
- the examiner assessing the positions available to locate a wheelchair within the vehicle, based on the tie down facilities installed. Wheelchair(s), provided by the presenter, as defined in Section 19 should be used for this exercise.

At the request of the applicant a vehicle with at least 4 seats and a load area not exceeding 40% of the length of the vehicle and a weight limit of 6500kg max mass may be classed as an M1 vehicle for the purpose of this manual

For information on other vehicle categories, the following DVSA IVA inspection manuals should be consulted.

- The Light Goods Vehicle IVA Inspection Manual for vehicle category N1
- The Heavy Goods Vehicle IVA Inspection Manual for vehicle categories N2 and N3
- The Bus and Coach IVA Inspection Manual for vehicle categories M2 and M3
- The Trailer IVA Inspection Manual for categories O1, O2, O3 and O4

## Approval Process

The IVA scheme for 'M1 vehicles' applies to

- **M1 Basic**
- **M1 Normal**

There are two levels of compliance to the IVA Approval process.

The Basic IVA requirement which is based around a visual inspection of the vehicle to assess its design and construction characteristics against the key EC technical areas. In most cases a visual inspection will be carried out and documentary evidence of compliance is not normally required, except for certain areas such as Gaseous Fuel tanks.

A vehicle subject to The Basic IVA Requirements is either:

- (a) left hand drive vehicle;
- (b) a personally imported vehicle;
- (c) an amateur built vehicle;
- (d) a vehicle manufactured in very low volume;
- (e) a vehicle manufactured using parts of a registered vehicle;
- (f) a rebuilt vehicle;
- (g) a motor caravan as defined in Annex II.A of the 2007 Directive;
- (h) an ambulance as defined in Annex II.A of the 2007 Directive;
- (i) a hearse as defined in Annex II.A of the 2007 Directive; or
- (j) an armoured vehicle as defined in Annex II.A of the 2007 Directive.

All other M1 vehicles are subject to The Normal IVA Requirements. This level of inspection requires documentary evidence to prove compliance with EC Directives for up to 12 key areas as listed in the Normal IVA General requirements section. Compliance with alternative standards is acceptable where specified.

The standards applicable are those given in each section of this manual, and in most cases dependent on the date of manufacture of the vehicle.

For Normal IVA the onus is on the applicant to provide evidence of compliance. This can, for example, be in the form of manufacturer's markings on the vehicle, an EC certificate of conformity for an incomplete or base vehicle and details of the systems approved, documentary evidence from the competent authority in the country of origin or the manufacturer, submission of a test report from an accredited testing authority or a combination of such elements, and it may also include a degree of visual examination and practical tests. Applicants may be required to dismantle certain parts of the vehicle to allow DVSA examiners to carry out a full and meaningful inspection.

Applications and supportive documentation will be assessed prior to the issue of an appointment for inspection.

### **Scope of inspection**

**The design and construction requirements applicable to road vehicles are contained within the Road Vehicles (Approval) Regulations 2009. The inspection procedures within this manual have been developed to assess as far as practicable the ability of the vehicle to comply with those Regulations. This manual is however not a legal interpretation of the Regulations. The issue of an Individual Approval Certificate (IAC) should not be taken as absolute evidence that the vehicle can legally be used on the road, since there may be other applicable requirements contained in other regulations.**

**NOTE:** The vehicle will be assessed for compliance in all modes of operation unless otherwise specified, for example

- in the case of a convertible vehicle, with the hood up and with the hood down.
- if dual fuelled, when running on each separate fuel source.
- if fitted with a remote engine air/fuel ratio adjustment device in minimum/maximum positions.

### **Method of Inspection**

The presenter may be required to open lockable compartments, remove engine covers, inspection/access panels, trims, and carpeting and dismantle certain parts of the vehicle to allow DVSA examiners to carry out a full and meaningful inspection.

**Where the vehicle is subject to Basic IVA, only the basic subjects are tested. Where a vehicle is subject to Normal IVA, all the Basic subjects are tested except those where documentary evidence is required, or has been provided.**

**If the examiner has any doubts over any item covered by documentary evidence, calculations or declarations, they have the right to ask for the original copies of these approvals / declarations which were accepted at time of application, to compare against the vehicle they are inspecting.**

Examiners shall assess all relevant aspects of the vehicle in respect of its overall construction. In making a decision, the examiner shall compare the materials of construction/manufacture, position, function and attachment of components and ensure equivalent levels of performance typically found with type approved vehicles

Any item which prevents a meaningful test to be conducted shall be deemed to be “temporary in nature”. The relevant test or assessment shall **not** be conducted and the IVA 30 (Refusal to issue IAC) will indicate that the item was “unable to be assessed”.

**The condition/absence of an item in isolation is not a reason for an item failing to meet the requirements. However if the condition of an item is such that a meaningful assessment cannot be made, then the IVA 30 should indicate that the applicable section/area was unable to be assessed and state the reason for this action. Examiners are not required to carry out a roadworthiness inspection but where obvious safety defects are noted the vehicle may be subject to prohibition action, The IVA certificate (IAC) will not be issued.**

**Where an item appears to be missing an assessment should be made of the effect the missing item will have on the suitability for use of the vehicle and the safety of the occupants, pedestrians and other road users. Where a missing item is considered to have a detrimental effect the IVA 30 (Refusal to Issue IAC) will indicate that either the item was unable to be assessed or that a required standard from the section ‘General Construction’ has not been met.**

### **Definitions of vehicles eligible for the Basic Scheme**

#### **a. Left hand drive vehicle**

Vehicles designed for use primarily on the right hand side of the road

#### **b. Personal Import**

A vehicle is a personally imported vehicle if all of the following apply

- it has been imported by a person entering the United Kingdom (in the case of a serving member of the Armed Forces, is to be imported within 12 months of the date of application)



- that person, at the time the vehicle was imported (in the case of a serving member of the Armed Forces, at the time of application) had been normally resident in a country other than the UK for a continuous period of at least 12 months
- that person intends to become normally resident in the UK
- the vehicle has been in the possession of that person and used by him in the country where he has been normally resident for a period of at least 6 months before its importation, and it is intended for his personal or household use in the UK.

#### c. **Amateur Built**

A vehicle is an amateur built vehicle if:

- (a) the vehicle was, constructed, assembled or having previously been registered under the 1994 Act, structurally modified, for the personal use of a person (R) who is a relevant individual, and
- (b) the whole, or a substantial part, of the construction, assembly or modification was carried out by R, by one or more relevant individuals acting on behalf, and under the direction, of R or by R and one or more relevant individuals acting on behalf, and under the direction of R.

#### d. **Very Low Volume**

A vehicle is of a family of types of which the total number manufactured in the world for any 12 months falling within the period of 36 months immediately before the month in which the vehicle was manufactured does not exceed 300.

**NOTE:** “family of types” means, of the same manufacturer, of the same basic chassis/floor pan.

#### e. **Vehicles manufactured using parts of a registered vehicle.**

A vehicle that

- is constructed or assembled by a person carrying on a business in the course of which motor vehicles are normally constructed or assembled
- is equipped with an engine which has previously been used as the engine of another vehicle which had been registered under the Vehicle Excise and Registration Act 1994 or any earlier Act relating to the registration of mechanically propelled vehicles, and
- is equipped with one or more of the following components taken from the same vehicle as the engine
  - chassis
  - body
  - suspension
  - transmission
  - steering assembly
  - an axle

#### f. **Rebuilt Vehicle**

A vehicle that

- is a previously UK registered vehicle to which the Secretary of State is required by regulation to assign a vehicle identification number, and does not fall within the definition of an “Amateur Built” vehicle or “Vehicle manufactured using parts of a registered vehicle,” and has been rebuilt using a replacement chassis or integral chassis/body which is of the same design and construction as that of the original vehicle and which was supplied for the purpose without having been previously used, or previously formed part of a registered vehicle. Evidence will be required to meet this definition.

#### g. **Motor Caravan**

A special purpose M1 category vehicle (vehicle having 8 or less passenger seats) which meets the “reasonableness test” and is constructed to include living accommodation which contains at least the following equipment.

- seats and table,
- sleeping accommodation which may be converted from the seats,
- cooking facilities, and
- storage facilities.

This equipment shall be rigidly fixed to the living compartment. The interpretation applied to this definition is as follows

##### Seats and a Table

- Are required to be an integral part of the living accommodation area, and mounted independently of other items.
- The table must be capable of being mounted directly to the vehicle floor and/or side wall.
- The table mounting arrangement must be secured as a permanent feature, (bolted, riveted, screwed or welded), although the table may be detachable.
- Permanently secured seating must be available for use at the table.
- The seats must be secured directly to the vehicle floor and/or side wall.
- The seats must be secured as a permanent feature, (bolted riveted, screwed or welded).

##### Sleeping Accommodation

- Must be an integral part of the living accommodation area.
- Either beds or beds converted from seats (to form a mattress base)
- Secured as a permanent feature, with base structures bolted, riveted, screwed or welded to the vehicle floor and/or side wall, (unless the sleeping accommodation is provided as a provision over the driver’s cab compartment.

##### Cooking Facilities

- That are an integral part of the vehicle living accommodation and is mounted independently of other items.
- That are secured to the vehicle floor and/or side wall.

- Secured as a permanent feature, (bolted, riveted, screwed, or welded).
- The cooking facility must consist of a minimum of a two ring cooking facility or a microwave in either case having a fuel/power source.
- If the cooking facility is fuelled by gas having a remote fuel supply, the fuel supply pipe must be permanently secured to the vehicle structure.
- If the cooking facility is fuelled by gas having a remote fuel supply, the fuel reservoir must be secured in a storage cupboard or the reservoir secured to the vehicle structure.

#### Storage Facilities

- Storage facilities must be provided by a cupboard or locker.
- The facility must be an integral part of the vehicle living accommodation, i.e. mounted independently of other items, unless incorporated below seat/sleeping accommodation or the cooking facility.
- The storage facility must be a permanent feature, (bolted, riveted, screwed or welded).
- The storage facility must be secured directly to the vehicle floor and/or side wall; unless a storage provision is provided over the driver's cab compartment.

#### **h. Motor Ambulance**

A motor vehicle of category M intended for the transport of sick and injured people and having special equipment for such purpose.

The interpretation applied to this definition is as follows:

The vehicle shall be readily identifiable as a vehicle used for the carriage of sick or injured people to or from welfare centres or places where medical or dental treatment is given by being permanently marked "Ambulance" (or "Ambiwans") on both sides and/or to the front and rear.

The vehicle must have the following equipment or characteristics;

- an optical warning system i.e.  
a blue warning beacon (or special warning lamp) or a device which fulfils the same function
- an acoustical warning system
- be fitted with features to enable the carriage of special equipment such as a stretcher, medical equipment or supplies such as oxygen cylinders.

#### **i. Hearse**

A vehicle intended for the transport of deceased people and having special equipment for the purpose.

This shall be interpreted as a vehicle:

- having an enclosed glazed area to the rear of the driving position,

- being fitted with a **permanent** deck of suitable length to accommodate a full size coffin incorporating bier fittings such as coffin stops and/or rollers, and
- not fitted with any seats or seat mountings below the deck/bier, (although storage space may be provided).

#### j. Armoured Vehicle

A vehicle intended for the protection of conveyed passengers and/or goods and complying with armour plating anti-bullet requirements.

"anti - bullet requirements" shall be interpreted as meaning; the driver and passenger compartment (front, rear and sides including doors and glazing are capable of withstanding ballistic penetration from small arms fire. e.g. materials to EN 1063 or an equivalent level of protection.

#### Refusal to examine

The examination of a vehicle may be refused for any of the following reasons

- the vehicle is not submitted for examination at the time and place appointed
- the fee has not been paid
- the vehicle submitted for examination is of the incorrect category
- the vehicle cannot be driven or has insufficient fuel or oil to enable the test to be completed
- the vehicle is presented in a dirty or dangerous condition such as to make it unreasonable for the examination to be carried out
- a load or items on the vehicle are not secured or removed as requested
- a proper examination cannot be carried out because any door, tailgate, boot lid, engine cover, fuel cap or other device designed to be readily opened cannot be opened
- the condition of the vehicle (in the opinion of the examiner) is such that proper examination of the vehicle would involve a danger of injury to any person or damage to the vehicle or any other property
- there is no means of identifying the vehicle, i.e. the vehicle identification number is missing or does not relate to the vehicle
- the presenter does not remain in the vehicle or its vicinity and operate the controls, drive the vehicle or to remove, refit panels as requested or is uncooperative.

#### Run Lock

Run lock systems are permitted on ambulances only. Vehicles falling outside of this definition will be considered on a case by case basis.

#### Work Instructions

Technical Work Instructions relating to the use and operation of equipment and facilities are issued and are made available to DVSA staff via the DVSA internal website. Copies of these instructions can be made available upon request from IVA Technical Services telephone 0300 123 9000 or email [enquiries@dvsa.gov.uk](mailto:enquiries@dvsa.gov.uk)

<b>Summarised list of requirements for Basic IVA and Normal IVA for Passenger Vehicles</b>					
<b>Section Number</b>	<b>Directive Requirement</b>	<b>As Amended by</b>	<b>UNECE Regulation</b>	<b>Basic IVA M1</b>	<b>Normal IVA M1</b>
1	70/157/EEC	92/97/EEC		Inspection	Approval & Inspection
2	70/220/EEC / 88/77/EEC	# Age related #		Inspection	Approval
3	70/221/EEC	2000/8/EC	67.01 / 110 / 115	Approval & Inspection	Approval & Inspection
4	70/222/EEC			Inspection	Inspection
5	70/311/EEC	1999/7/EC		Inspection	Inspection
6	70/387/EEC	2001/31/EC		Inspection	Inspection
7	70/388/EEC	87/354/EC		Inspection	Inspection
8	71/127/ EEC	88/321/ EEC		Inspection	Inspection
9	71/320/EEC	# Age related #		Inspection	Approval
10	72/245/EEC	89/491/EEC		Inspection	Inspection
12	74/60/EEC			Inspection	Inspection
13	74/61/EEC	95/56/EC		Inspection	Approval & Inspection
14	74/297/EEC	91/662/EEC		Inspection	Approval
15 & 38	74/408/EEC & 78/932/EEC	2005/39/EC		Inspection	Inspection
16	74/483/EEC	79/488/EEC		Inspection	Inspection
17	75/443/EEC	97/39/EC		Inspection	Inspection
18	76/114/EEC	78/507/EEC		Inspection	Inspection
19	76/115/EEC	# Age related #		Inspection	Approval
20	76/756/EEC	2007/35/EC	48.03	Inspection	Inspection
21	76/757/EEC	97/29/EC		Inspection	Inspection
22	76/758/EEC	97/30/EC		Inspection	Inspection
23	76/759/EEC	99/15/EC		Inspection	Inspection
24	76/760/EEC	97/31/EC		Inspection	Inspection
25	76/761/EEC	99/17/EC	119 (Cornering lamps)	Inspection	Inspection
26	76/762/EEC	98/18/EC		Inspection	Inspection

**Foreword**

<b>Summarised list of requirements for Basic IVA and Normal IVA for Passenger Vehicles</b>					
<b>Section Number</b>	<b>Directive Requirement</b>	<b>As Amended by</b>	<b>UNECE Regulation</b>	<b>Basic IVA M1</b>	<b>Normal IVA M1</b>
28	77/538/EEC	99/14/EC		Inspection	Inspection
29	77/539/EEC	97/32/EC		Inspection	Inspection
30	77/540/EEC	99/16/EC		Inspection	Inspection
31	77/541/EEC	# Age related #		Inspection	Inspection
32	77/649/EEC			Inspection	Inspection
33	78/316/EEC	94/53/EC		Inspection	Inspection
34	78/317/EEC			Inspection	Inspection
35	78/318/EEC			Inspection	Inspection
36	2001/56/EC			Inspection	Inspection
37	78/549/EEC	94/78/EC		Inspection	Inspection
39	80/1268/EEC	# Age related #			Approval
44	92/21/EEC	95/48/EC		Inspection	Inspection
45			43.00	Inspection	Inspection
46	92/23/EC	2005/11/EC	64.01 (Temporary use spare)	Inspection	Inspection
50	94/20/EC			Inspection	Inspection
53	96/79/EC	# Age related #			Approval
54	96/27/EC	# Age related #			Approval
60	2005/66/EC			E marked	E marked
62	EC/79/2009	EU/406/2010		Approval & VSO*	Approval & VSO*
69			100.01	Approval & Inspection	Approval & Inspection

# Age related - see relevant sections for further information

\* VSO – Vehicle Special Order, issued by VCA

**Special Purpose Vehicles Exemption Table**

<b>Section Number</b>	<b>Subject area</b>	<b>Type of SPV</b>	<b>&lt; 2500kg Exemptions apply</b>	<b>≥ 2500kg Exemptions apply</b>
1	Noise	MC, AM and HE	YES	YES
2	Emissions	MC, AM, AV and HE	YES	YES
7	Horn	AV	YES	YES
8	Rear vision	MC, AM, HE and AV	NO	YES
12	Interior fittings	MC, AM, AV and HE	YES	YES
13B	Anti theft/Immobiliser	AV	NO	YES
14	Protective steering	MC, AM and HE	NO	YES
15	Seat strength (head rests added)	MC, AM, HE and AV	YES	YES
16	Exterior projection	MC, AM, HE and AV	YES	YES
19	Seat belt anchorage	MC, AM, HE and AV	YES	YES
20	Lighting installation	MC, AM, HE and AV	YES	YES
31	Seat belts	MC, AM, HE and AV	YES	YES
44	Masses & Dimensions	MC	YES	YES
45	Glass	AV	YES	YES
46	Tyres	AV	YES	YES

MC = Motor Caravan, AM = Ambulance, HE = Hearse and AV = Armoured Vehicles

Details of the particular exemptions are contained in each relevant section of the manual.



## Record of Revision

Revision	Date	Description of Change
1	27/03/2009	
2	09/04/2009	Text added to statement in the Foreword Application “and a weight limit of 6500kg max mass”
3	24/05/2010	Amended reference to bulletproof glass and summarised requirements
4	05/05/2011	Remove Item 11 from the Summarised Table of requirements
5	31/10/2011	Inserted definition of a ‘WAV’ and availability of Work Instructions to public
6	29/04/2012	Remove (k) a wheelchair accessible vehicle as defined in Annex II.A of the 2007 Directive.
7	21/05/2012	Amend wording in section ‘Method of Inspection’.
8	30/09/2012	Determination of the number of wheelchair spaces
9	17/06/2013	Reword paragraph 3 on page 3, remove paragraph k (transfer to Glossary), reword bullet point 9 on page 8, remove 2 <sup>nd</sup> line from header on page 11 and add reference to ‘Run Lock’.
10	03/10/2016	DVSA replaces VOSA. New paragraph added to page 4. SPV Exemption Table updated. Summarised list of requirements updated.

This page intentionally left blank

## Non-European and Other Acceptable Standards

Evidence that a vehicle complies with the standards in the table will be accepted instead of compliance with the relevant Basic IVA and IVA requirements, where evidence is provided physical inspection is not required unless there is evidence of modifications. This does not necessarily mean that these standards are equivalent to the IVA requirements but they do guarantee a suitably high level of safety.

Mass-Produced Vehicles from USA or Canada.

To prove compliance with the listed standards, these vehicles must be fitted with a Compliance plate which will contain the name of manufacturer, 17 digit VIN number, gross vehicle weights, and the following:

For FMVSS: *'This vehicle conforms to all applicable Federal Motor Vehicle Safety Standards in effect on the date of manufacture shown above'*.

For CMVSS: The plate will contain bilingual text (English/French) and a Transport Canada maple leaf containing a number



Such vehicles will be exempt from inspection in respect to certain sections of the manual. However in the case of modified vehicles, especially stretch limousines, modifications to the vehicle may have invalidated the original compliance and so enquiries will need to be made of the converter, in particular whether any increase in maximum permissible weights is technically justifiable and whether the brakes have likewise been uprated

Mass produced vehicles from Japan.

To prove compliance with the listed standards, a Japanese de-registration document (or equivalent, original not a copy) must be provided when the vehicle is presented for test. It must contain a Type Designation number. Such vehicles will only need to be tested to certain sections of the manual. However, in the case of modified vehicles, the original compliance may be invalidated and this must be assessed on a case-by-case basis.

Mass produced vehicles from other territories: DVSA will update this manual from time to time with the latest information.

## Non-European and Other Acceptable Standards

<b>M1 Comparable Standards - IVA and BIVA</b>					
<b>Section No.</b>	<b>Subject area</b>	<b>United States (U)</b>	<b>Canada (C)</b>	<b>Japan (J)</b>	<b>OTHER</b>
1	Noise	California (SAE J986)	CMVSS 1106	Std accepted	ADR 83/00
2	Emissions	EPA 40 CFR Part 86 or California TLEV, LEV or ULEV	CMVSS 1100	Std accepted for vehicles registered in J for at least 6 months	ADR 79/01 Euro III (petrol & diesel) Euro IV (diesel) ADR 79/02 Euro IV (petrol & diesel) ADR 79/03 Euro V (petrol & diesel)
3	Fuel tank	FMVSS 301 FMVSS 303 – Fuel system integrity of compressed natural gas vehicles FMVSS 304 – Compressed natural gas fuel container integrity	CMVSS 301 CMVSS 301.1 – LPG fuel system integrity CMVSS 301.2 – CNG fuel system integrity	Std accepted Japan 11-1-Art 17 – Gas fuel systems Japan 11-1-Art 17 and 11-6-27 – CNG fuel system construction requirements	ADR 44/02 – Specific purpose vehicle requirements – LPG fuelled vehicles
6	Door latches	FMVSS 206	CMVSS 206	11-4-12 (door retention systems)	
8	Rear vision	FMVSS 111	CMVSS 111		
9	Braking	FMVSS 135 or FMVSS 105 + ABS on rear wheels	CMVSS 135 or CMVSS 105 +ABS on rear wheels	11-4-29 (braking systems) +ABS on rear wheels#	ADR 31/01
10	EMC/RFI	SAE J551	SAE J551	Std accepted	
11	Diesel smoke	EPA 40 CFR Part 86 or California TLEV, LEV or ULEV	Std accepted - ref TBC	11-4-26 (10.15 mode: diesel particulate standard)	
12	Interior fittings	FMVSS 201 excluding the rear passenger compartment of Limousines,	CMVSS 201 excluding the rear passenger compartment of Limousines,	11-4-6 (instrument panel) 11-4-7 (sun visors) 11-4-9 (seat backs) (J2)	

## Non-European and Other Acceptable Standards

<b>M1 Comparable Standards - IVA and BIVA</b>					
<b>Section No.</b>	<b>Subject area</b>	<b>United States (U)</b>	<b>Canada (C)</b>	<b>Japan (J)</b>	<b>OTHER</b>
13	Anti theft/immobiliser	FMVSS 114	CMVSS 114	Std accepted for vehicles first registered In J after 01/07/2006	ADR 82/00 (immobiliser only) In conjunction with steering lock
14	Protective steering	FMVSS 203 FMVSS 204	CMVSS 203 CMVSS 204	11-4-1 (steering system impact) (J3)	ADR 69/00 (plus drivers airbag) or ADR 73/00
15	Seat strength (+ head rests)	FMVSS 207	CMVSS 207	11-4-8 (seats and seat anchorages) (J1)	
17	Speedometer /reverse	FMVSS 101 Excluding reverse gear	CMVSS 101 Excluding reverse gear		
19	Seat belt anchorage	FMVSS 210 including associated requirements of FMVSS 207 and 208	CMVSS 210 including associated requirements of CMVSS 207 and 208	11-4-10 (seat belt anchorages)	ADR 5/04 and ADR 73/00
31 a	Seat belts components	FMVSS 209	CMVSS 209	Std accepted	
31 b	Installation of seat belts	FMVSS 208	CMVSS 208	Std accepted	
33	ID of Controls	FMVSS 101	CMVSS 101		
34	Defrost/Demist	FMVSS 103	CMVSS 103	11-4-33 (defrosting and demisting systems)	
35	Wash/Wipe	FMVSS 104	CMVSS 104	Std accepted	
38	Head restraints (see item 15)	FMVSS 202	CMVSS 202	Std accepted	
39	Fuel consumption				ADR 81/01
41	Heavy Duty diesel gaseous emissions	Std accepted - ref TBC	Std accepted - ref TBC	Std accepted for vehicles registered in J for at least 6 months –	
45	Glass	FMVSS 205 (U1)	CMVSS 205 (C1)	11-4-21 (window glass) JIS R3211	South Africa SABS 1191 SABS 1193
					India IS2553 (Part 2) 1992 (Note I1)

## Non-European and Other Acceptable Standards

<b>M1 Comparable Standards - IVA and BIVA</b>					
<b>Section No.</b>	<b>Subject area</b>	<b>United States (U)</b>	<b>Canada (C )</b>	<b>Japan (J)</b>	<b>OTHER</b>
					Australia AS/NZS 2080 AS/NZS 2080T (Note A1)
46	Tyres	FMVSS 109 (U2)	CMVSS 110 (C3)	JIS D4201 (marking)	
		FMVSS 110 (U3)	CMVSS 119/120	JIS D4202 (dimensions)	
		FMVSS 119/120	CMVSS 139	JIS D4230 (performance)	
		FMVSS 139			
50	<b>Couplings (if fitted)</b>				
53	Frontal Impact (if <2500kg GVM)	FMVSS 208	CMVSS 208	Std accepted	ADR 73/00
54	Side impact (if <700mm R point)	FMVSS 214	CMVSS 214	Std accepted	ADR 72/00
60	Frontal protection systems <b>(if fitted)</b>				
69	Electric/Hybrid Vehicles			Std accepted	

This information is provided for guidance only and DVSA retains the right to test the vehicle against the IVA requirements if they have any reason to doubt compliance with the indicated standard.

U) FMVSS = Federal Motor Vehicle Safety Standards

C) CMVSS = Canadian Motor Vehicle Safety Standards

SAE = Society of Automotive Engineers (standard)

EPA 40 CFR = Environmental Protection Agency, Code of Federal Regulation, Title 40

ADR = Australian Design Rules

J) The references 11-4-(digit) are the relevant sections of the Automotive Type Approval Handbook for Japanese Certification published by the Japan Automobile Standards International Centre in the respective years listed (1997).

JIS = Japanese Industrial Standard.

## **Non-European and Other Acceptable Standards**

A1) Does not include opacity. Must display manufacturer's name or trademark. Windscreen to show 2080 and WHP. Other windows 2080T and CHT, L, LT, LCHT or HP.

A2) Vehicles having a date of manufacture pre- 1/10/96

A3) Vehicles having a date of manufacture from 1/10/96

I1) Does not include opacity. Must display manufacturer's name or trademark. Windscreen to show Z or LW. Other windows T, TW, Z, L or LW.

J1) Does not address location of unlocking controls or automatic locking of seats.

J2) Other areas are not addressed.

J3) Only addresses steering wheel/column energy absorption requirement of paragraph 3.

J4) Does not confirm compliance in respect of longitudinal brake distribution.

U1 and C1) Glass bearing the following marking complies with FMVSS 205 and CMVSS 205

- in the case of a windscreen – AS1 or AS10
- in the case of a window wholly or partly on either side of the driver's seat – AS1, AS2, AS10, AS11A
- In any other case – AS1, AS2, AS3, AS10, AS11A, AS14, AS15, AS16.

U2) Tyre speed capability may not be sufficient. It must be no less than the vehicle design speed (or fixed speed limiter speed, where fitted).

U3 and C3) Non-pneumatic spare tyres are illegal for use in Great Britain.

# For vehicles without ABS on rear wheels we will have to carry out a brake distribution test as shown in 09E Basic IVA  
(Japanese pre 2004 vehicles having a deregistration document)

**Note:** Even though we accept the comparable standard for the relevant Basic IVA and IVA sections, we still have to carry out a condition check where necessary.

## Non-European and Other Acceptable Standards

## Record of Revision

Revision	Date	Description of Change
1	27/03/2009	
2	28/04/2009	Note added for condition check
3	24/05/2010	Remove the term TBC from the standards columns, and added text to clarify that physical inspection is not required when other evidence is provided. Added reference to ADR 79/02 and corrected reference to note I1
4	09/05/2011	Acceptance of the Japanese Standard for Anti - Theft / Immobiliser on vehicles first registered after 01/07/2006
5	17/06/2013	Update Section 2 (Other) ADR/Euro V, Insert ADR = Australian Design Standard
6	03/10/2016	Update Section 19 (Other) from ADR 69/00 to ADR 73/00, add Section 69

## Non-European and Other Acceptable Standards



# IVA Manual with Basic Requirements

Where a vehicle subject to The Basic IVA Inspection is accompanied by voluntary documentary evidence, the examiner must be satisfied that such evidence fully satisfies the IVA requirements relating to the vehicle **as presented**. In cases where the evidence is unsatisfactory the procedures and standards for that section or area must be fully applied.

## Record of Revision

Revision	Date	Description of Change
1	27/03/2009	

# 01 Noise

**Application:** Vehicles subject to Basic requirements

Method of Inspection	Required Standard
<p>This inspection applies to the exhaust system fitted to the engine which provides the motive power for the vehicle.</p> <p>In the case of a <b>motor caravan, ambulance or hearse with a base vehicle approval</b>, modification to the exhaust system length after the rear silencer not exceeding 2m in length are permissible without further test.</p> <p>Conversions that are not based on M1 vehicles may comply with the applicable requirements of the original base vehicle.</p> <p>Documentary evidence of base or incomplete vehicle approvals will be deemed acceptable.</p> <p>N1 base vehicle approval will be acceptable in all instances</p> <p>N2 base vehicle approval will be accepted provided gross vehicle weight of vehicle is at least 3500kg</p> <p>Using sound level meter to the manufacturer's instructions, carry out a stationary noise check.</p> <p>Position the vehicle within the authorised test area. With the sound meter horizontal, set the microphone height so that it is at the height of the exhaust outlet or 200mm from the ground, whichever is higher.</p> <ol style="list-style-type: none"> <li>a. At an angle of 45 degrees to the exhaust outlet in the direction which gives the greatest distance between it and the vehicle contour</li> </ol>	<p><b>Exhaust Systems</b></p> <ol style="list-style-type: none"> <li>1. Must be securely mounted.</li> <li>2. Must have all components secure.</li> <li>3. Must not leak. See <b>Note 1</b></li> <li>4. Must be fitted with a silencer.</li> <li>5. Must have a measured sound level not exceeding 99dBA.</li> </ol>

## Noise 01

Method of Inspection	Required Standard
<p>b. At a distance of 500mm from the exhaust outlet.</p> <p>With the vehicle at normal operating temperature, run the engine at <math>\frac{3}{4}</math> of its 'maximum power' speed, and note the sound level reading obtained.</p> <p><b>Note 1:</b> Manufacturers drain holes are permitted in silencers</p> <p><b>Note 2:</b> The exhaust may have several outlets up to 300mm apart connected to the same silencer. In this instance the microphone must face the outlet closest to the vehicle contour or highest from the ground. In all other cases, separate measurements must be taken for each exhaust outlet; the highest value obtained is the test value.</p> <p><b>Note 3:</b> Where the engine maximum power speed is not available, the test may be carried out at <math>\frac{2}{3}</math> of engine maximum design speed.</p>	

## Record of Revision

Revision	Date	Description of Change
1	27/03/2009	
2	24/05/2010	Amended and clarified MOI in line with TSE IVA 000M1 05 001

This page intentionally left blank

## 02A Visual Emissions

**Application:** Vehicles subject to Basic requirements fitted with a Spark Ignition Engine

Method of Inspection	Required Standard
<p><b>All vehicles</b> Raise the engine speed to around 2500rpm or half the maximum engine speed if this is lower. Hold this speed steady for 20 seconds to ensure that the inlet and exhaust system is properly purged. Allow the engine to return to idle and the emissions to stabilise.</p> <ul style="list-style-type: none"><li>• Assess the engine idle speed.</li><li>• Assess the smoke emitted from the tailpipe at idle.</li><li>• Rapidly increase the engine speed to around 2500rpm or half maximum engine speed if this is lower and assess the smoke emitted from the tailpipe. Allow the engine to return to idle.</li></ul>	<ol style="list-style-type: none"><li>1. The engine must be idling at its normal idling speed.</li><li>2. The exhaust must not emit dense blue or clearly visible black smoke for a continuous period of 5 seconds at idle speed.</li><li>3. The exhaust must not emit excessive smoke or vapour of any colour during acceleration which would obscure the view of other road users.</li></ol>

## Record of Revision

Revision	Date	Description of Change
1	27/03/2009	



## 02B Metered Emissions

**Application:** Vehicles subject to Basic requirements (except mass produced hybrid vehicles)

Method of Inspection	Required Standard
<p>When checking the exhaust emissions, the engine must be at its normal idle speed and normal operating temperature. Engine speed and temperature can be assessed either subjectively or by reference to manufacturer's or other reliable data.</p> <p><b>Vehicles fitted with spark ignition except:</b></p> <ul style="list-style-type: none"> <li>• Vehicles with an effective date Pre 1975</li> <li>• a rotary engine vehicle having an effective date before 1 August 1987.</li> <li>• a 2 stroke engine vehicle</li> <li>• vehicles fuelled by CNG (Compressed Natural Gas) in respect of the requirement to check Hydrocarbons</li> </ul> <p>Conversions that are not based on M1 vehicles may comply with the applicable requirements of the original base vehicle. Documentary evidence of base or incomplete vehicle approvals will be deemed acceptable, Modification to the exhaust system length after the rear silencer will be permissible without further test</p> <p>In the case of a <b>motor caravan, ambulance or hearse</b> the requirements according to the category of the base or incomplete vehicle based on maximum mass may apply. An EC type-approval issued to the most representative base vehicle remains valid irrespective of change in the reference mass.</p>	<ol style="list-style-type: none"> <li>1. There must be access to the exhaust tailpipe(s) to allow the insertion of the analyser probe.</li> <li>2. The exhaust gas must not contain carbon monoxide content exceeding the limit for a continuous period of 5 seconds</li> <li>3. The exhaust gas must not contain hydrocarbon content exceeding the limit for a continuous period of 5 seconds.</li> </ol>

## Metered Emissions 02B

Method of Inspection	Required Standard
<p>In the case of <b>Armoured</b> vehicles exemption from any requirement of this section is permitted if it can be demonstrated to the satisfaction of the Approval Authority that it is impossible for the vehicle to comply due to its special purpose.</p> <p>Check that the analyser probe can be inserted into the tailpipe. Use a suitable exhaust gas analyser to determine the proportions of carbon monoxide (CO) and hydrocarbons (HC) in the exhaust gas over a period of at least 5 seconds at idle.</p> <p>For vehicles with multiple tailpipes linked to separate exhaust systems an average reading should be calculated.</p> <p><b>Note:</b> If a vehicle meets the CO requirement at its normal idling speed but fails the HC check, re-check the HC level at a high idle speed of 2000rpm. If the HC reading is then 1200ppm or less, the vehicle will meet both the CO and HC requirements</p> <p><b>Note:</b> In the case of a dual fuelled vehicle there is only a requirement to check the emissions with the engine running on both fuels where the petrol fuel tank has a capacity of 15 litres or more. Where the capacity of the petrol fuel tank is less than 15 litres there is no requirement to check the emissions with the engine running on petrol.</p>	

## Metered Emissions 02B

Method of Inspection	Required Standard
<p>Check that the analyser probe can be inserted into the tailpipe</p> <p><b>If the vehicle fails the BET Test then;</b></p> <p>Carry out a CAT1 or CAT 2 Test</p>	<p>4. The emission limits must be met as prescribed in the flow charts below for CAT1 or CAT 2</p>

Carry out the test using the flowchart.

Ensure that the engine is hot by checking for example temperature gauge, cooling fan cut-in or hot coolant hoses. If the engine is not at normal temperature raise the engine speed to between 2000 and 3000rpm and maintain this speed until normal temperature has been reached.

Attach engine speed measuring device. It is permissible for the purposes of this check to use the vehicle tachometer.

Ensure the engine is idling normally.

Perform a HC hang-up check and ensure that HC<20ppm before continuing. Insert the analyser sample probe.

**Fast idle test:** Raise the engine speed to a fast idle between 2500 and 3000rpm and hold steady. Note the readings for CO, HC and lambda, and record the results.

**Idle test:** Allow the engine to idle. Note the CO reading and record the result.

Remove analyser sample probe.

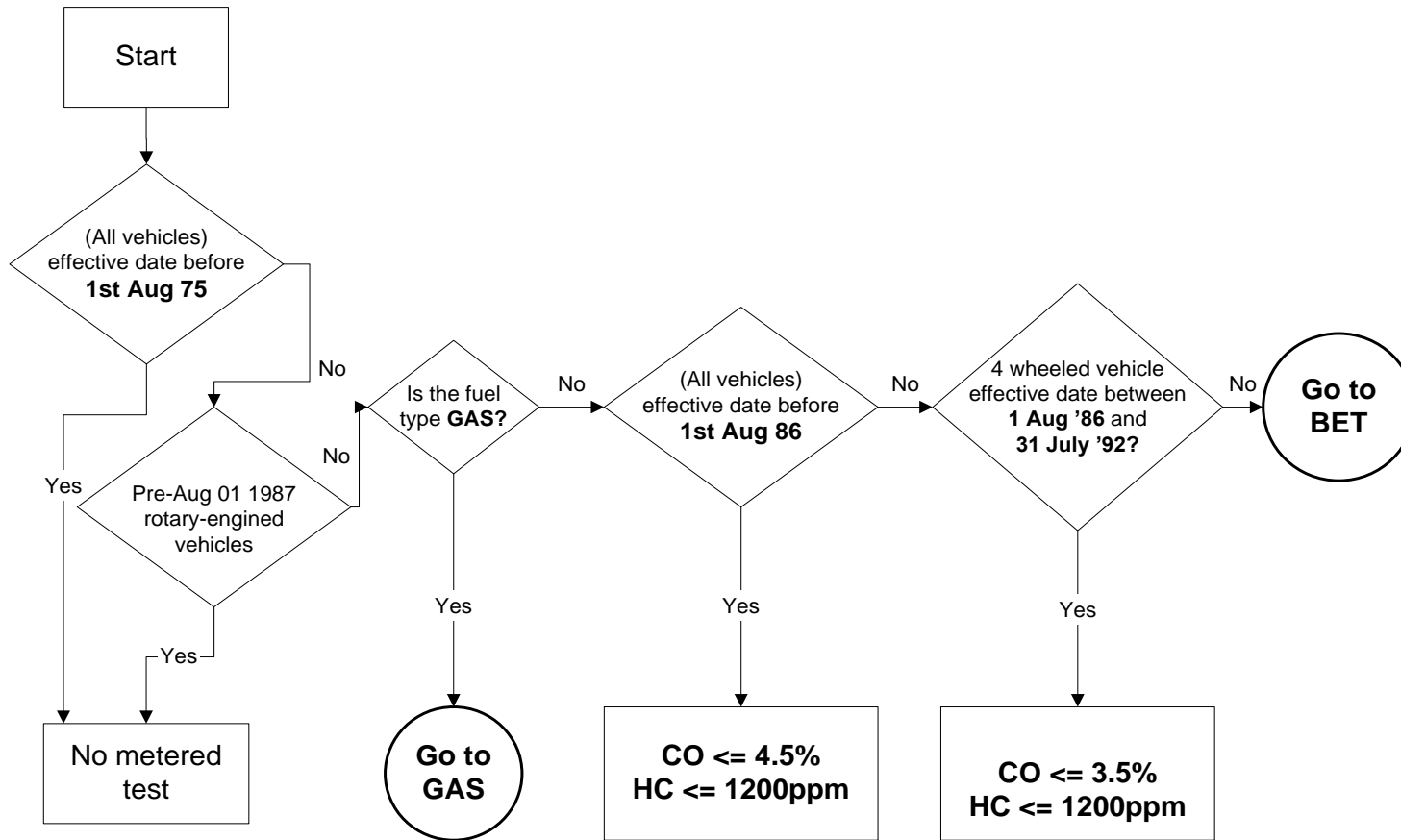

## Metered Emissions 02B

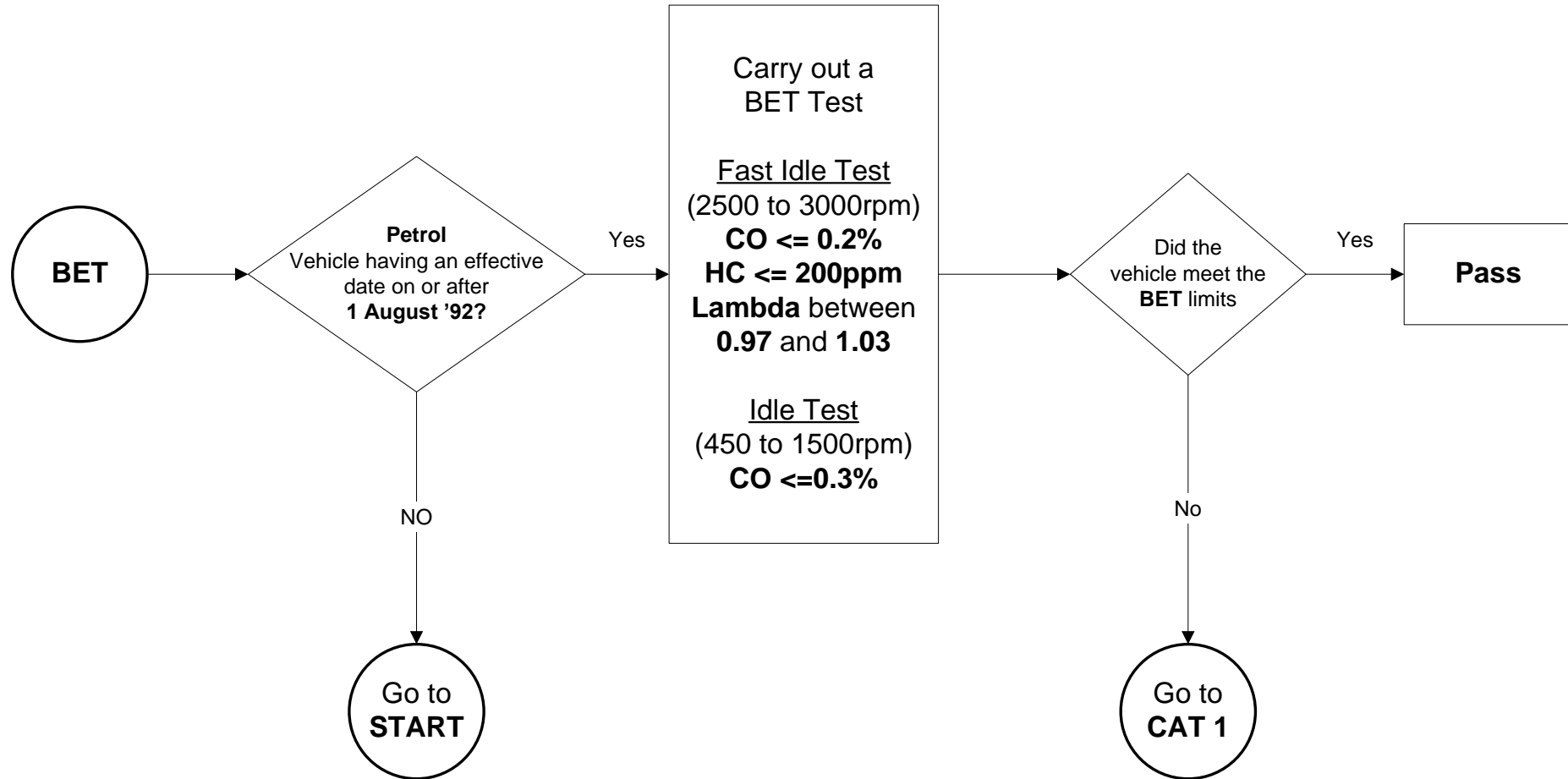

**All vehicles fitted with a spark ignition engine except**

- a. vehicles fuelled by LPG or CNG (liquid petroleum gas or compressed natural gas) in respect of the requirement to check the value of lambda.
- b. vehicles fuelled by CNG in respect of the requirement to check Hydrocarbons.
- c. vehicles fuelled by LPG or CNG having an effective date in the case of a “passenger car” from 1 August 1992 30 September 1999
  - in the case of other four or more wheeled vehicles from 1 August 1994 - 30 September 1999 to which the requirements apply when running on LPG/CNG as if the vehicle had an effective date of 1 August 1986 (i.e. non-catalyst test).
- d. vehicles that are listed in the current edition of the “In Service Exhaust Emission Standards for Road Vehicles” publication that are
  - passenger cars having an effective date from 1 August 1992 - 31 July 1995
  - other four or more wheeled vehicles having an effective date from 1 August 1992 - 31 July 1997

**Identify the vehicle specific test limits using the flow charts**

Connect the engine speed measuring device and insert the engine oil temperature measuring probe into the dipstick hole

**Engine pre-conditioning:** Check the engine oil temperature. If it is below the minimum vehicle specific requirement, raise the engine speed to between 2000 and 3000rpm and maintain this speed until the minimum engine oil temperature has been reached. Remove temperature measuring probe and replace dipstick

Perform a HC hang-up check and ensure that HC<20ppm before continuing. Insert the analyser sample probe

**1st Fast Idle Test:** Raise the engine speed to the vehicle specific fast idle speed and maintain for 30 seconds. If the engine speed drifts outside the fast idle speed range, begin the 30 second countdown again. During the last 5 seconds note the readings for CO, HC and lambda, and record the results

If the vehicle has passed the first fast idle test, then go to Idle Test otherwise go to Additional Engine Pre-conditioning

**Additional engine pre-conditioning:** Run the engine between 2000-3000rpm for 3 minutes or until all the emissions are within limits. If the engine speed goes outside the fast idle range, then freeze the countdown until the rpm is once again within the prescribed limits

**Catalyst stabilisation:** Raise the engine speed to the vehicle specific fast idle speed and maintain for 30 seconds. If the engine speed drifts outside the fast idle speed range then begin the 30 second countdown again

## Metered Emissions 02B

**Idle test:** Allow the engine to idle during a 30 second countdown. During the last 5 seconds, note the CO reading and record the result I. Remove analyser sample probe and engine speed measuring device.

**Notes:**

**When to do the test**

It is recommended that the extended test is carried out as soon as possible after the BET. This allows the test to be carried out on a fully warmed up engine.

**Working environment**

To prevent the build up of fumes, the test should be carried out in a well ventilated area.

**Gas analyser probe**

It is important to ensure that the gas analyser probe is inserted as fully as possible into the exhaust tail-pipe and is secure.

**Cosmetic engine covers:** Where engine speed can only be measured by the removal of a cosmetic engine cover, the engine speed must be measured if the cover can be easily un-clipped. Otherwise, engine speed measurement may be by-passed.

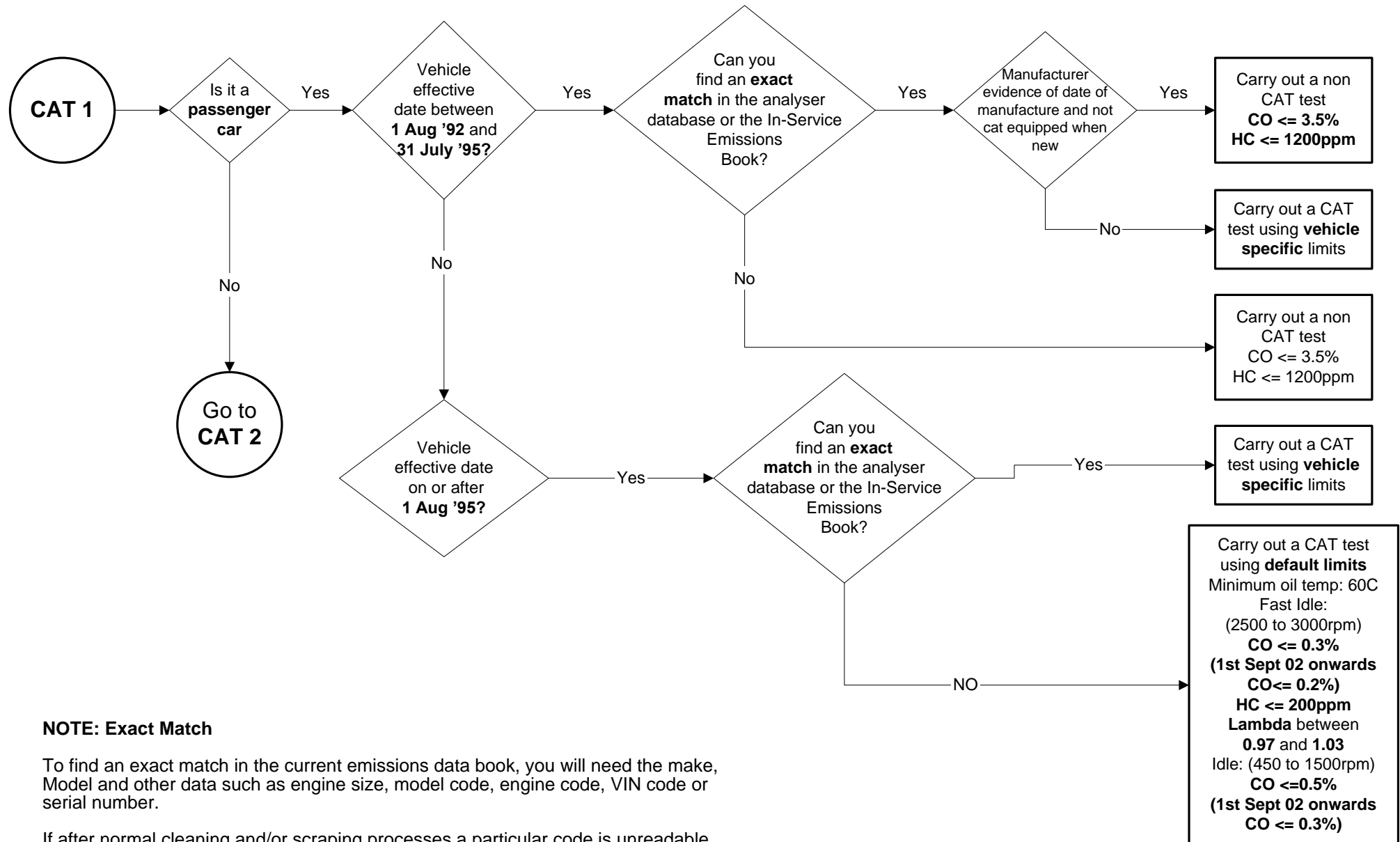

**NOTE: Exact Match**

To find an exact match in the current emissions data book, you will need the make, Model and other data such as engine size, model code, engine code, VIN code or serial number.

If after normal cleaning and/or scraping processes a particular code is unreadable or inaccessible, carry out as if no exact match can be found.

**Metered Emissions 02B**



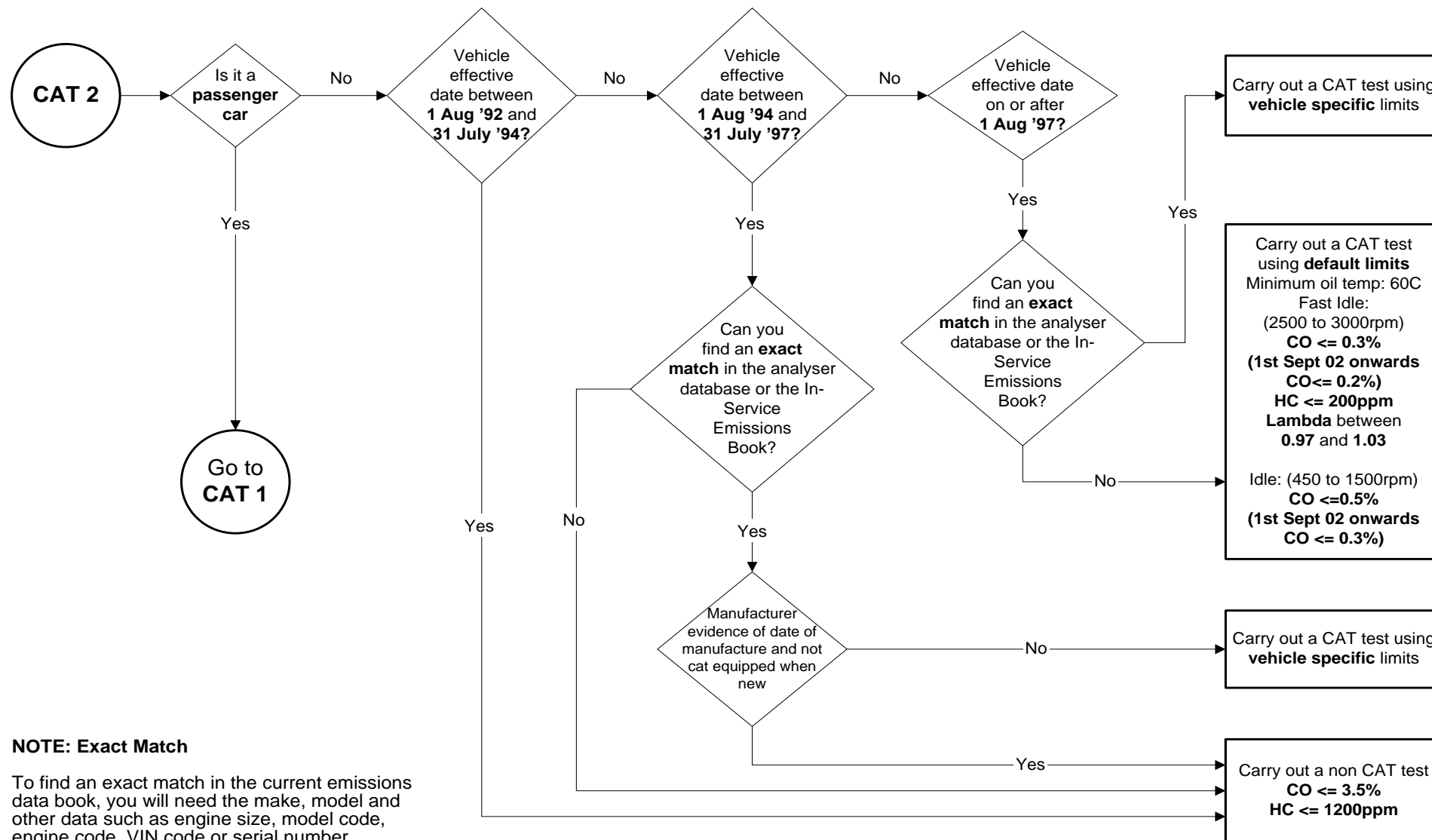

**NOTE: Exact Match**

To find an exact match in the current emissions data book, you will need the make, model and other data such as engine size, model code, engine code, VIN code or serial number.

If after normal cleaning and/or scraping processes a particular code is unreadable or inaccessible, carry out as if no exact match can be found.

# Metered Emissions 02B

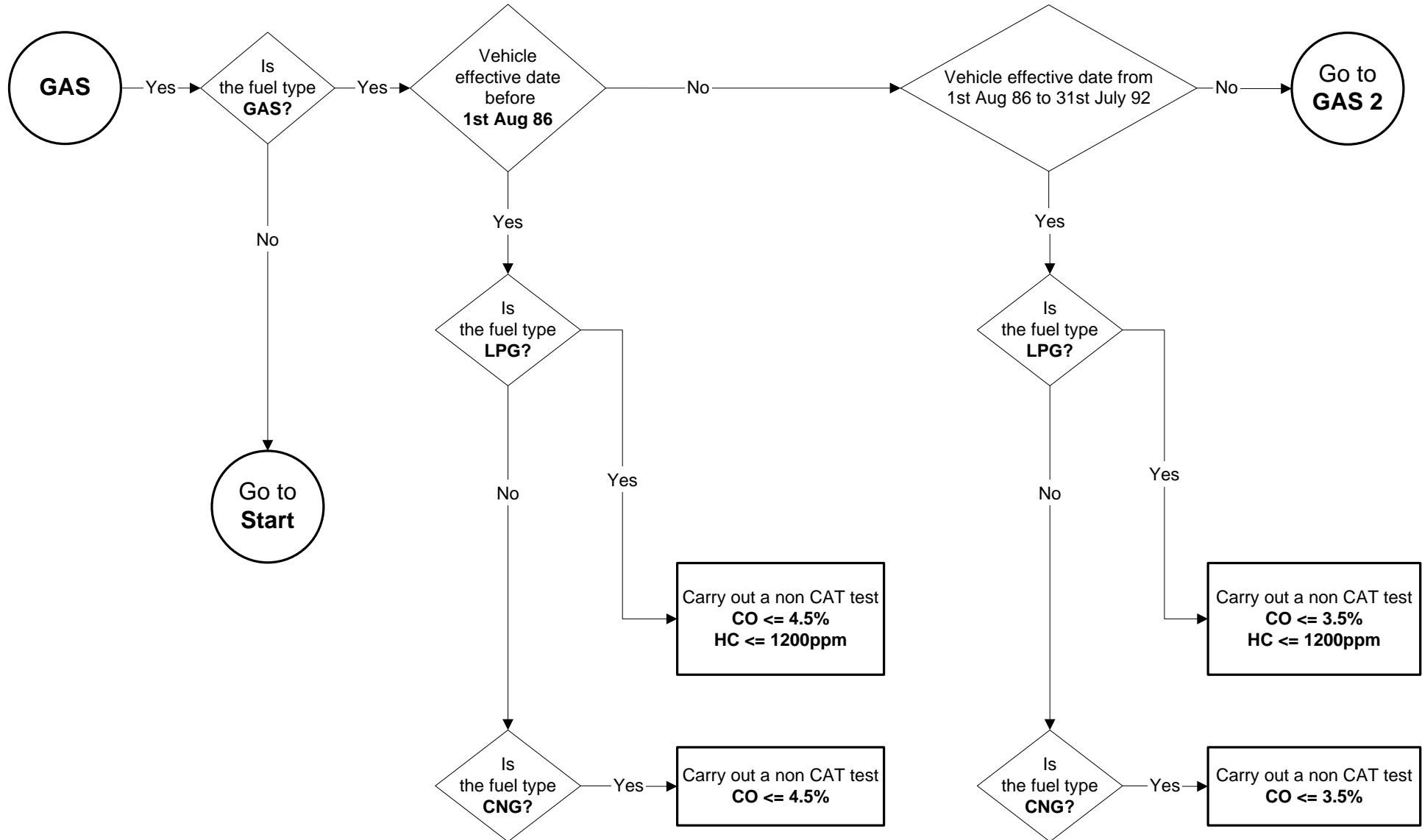

## Metered Emissions 02B

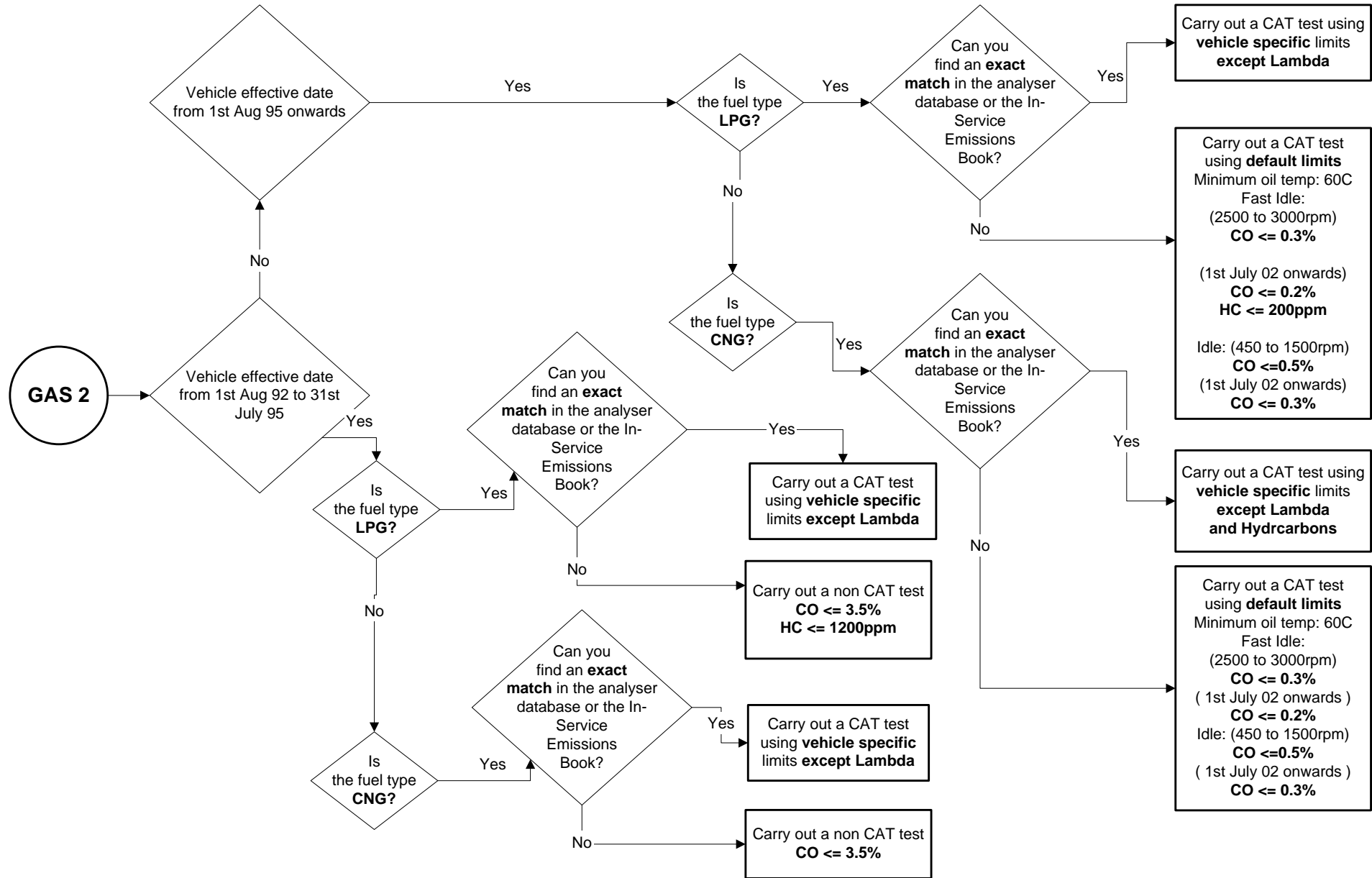

**“Effective Date”**

The “effective date” used to determine the criteria applicable is - the date of manufacture of the vehicle, except for an “Amateur Built” vehicle, a “Vehicle manufactured using parts of a registered vehicle” or a “Rebuilt vehicle” it shall be 1 January immediately preceding the date of manufacture of the vehicle’s engine if this is earlier.

If the “effective date” cannot be determined, it must be assumed to be on or after 1 August 1997.

**Automatic transmission**

When testing vehicles fitted with automatic transmission care must be taken to avoid overheating the transmission system. Do not carry out unnecessary engine acceleration or prolonged high revving of the engine. Reference to vehicle manufacturer’s instructions may be necessary.

**"Passenger car"**

Means a motor vehicle which -

- (a) is constructed or adapted for use for the carriage of passengers and is not a goods vehicle;
- (b) has no more than five seats in addition to the driver's seat; and
- (c) has a weight not exceeding 2,500 kg maximum gross;

## Record of Revision

Revision	Date	Description of Change
1	27/03/2009	
2	09/04/2009	BET limits updated
3	24/05/2010	Add text to clarify that mean value should be calculated for vehicles with multiple exhaust systems, Amended MOI to clarify and align with RVAR 2009, removed lambda values from flowchart for LPG vehicles.
4	28/02/2011	Amend application to remove requirement for mass produced hybrid vehicles, remove duplicated RS
5	31/07/2011	Correct 1st flowchart reference to Pre-87 Rotary-engined vehicles
6	29/04/2012	Insert new note – petrol tanks capacity less than 15 litres
7	17/06/2013	Reword the second note on page 2 and exceptions (c) on page 6

This page intentionally left blank

## 02C Diesel Emissions

**Application:** Vehicles subject to Basic requirements (except mass produced hybrid vehicles)

Method of Inspection	Required Standard												
<p>Where possible check that:</p> <ul style="list-style-type: none"> <li>• there is sufficient oil in the engine,</li> <li>• the oil pressure is not too low,</li> <li>• the camshaft belt is in a satisfactory condition,</li> <li>• there is no abnormal engine noise,</li> <li>• the governor has not been tampered with,</li> <li>• the engine is at normal operating temperature,</li> </ul> <p>Raise the engine speed to around 2500rpm or half the maximum engine speed if this is lower and hold for 30 seconds to fully purge the inlet and exhaust system.</p> <p>Raise the engine speed slowly to maximum to check the operation of the governor. Once the engine speed has stabilised or if it becomes clear that the governor is not working, release the pedal, return to idle and stop the engine.</p> <ol style="list-style-type: none"> <li>a. Prompt the meter to carry out a zero check.</li> <li>b. Check that the smoke meter probe can be inserted into the tailpipe.</li> <li>c. Insert the probe fully and securely, in line with the gas flow. Restart the engine.</li> </ol> <p><b>Fast Pass</b> Following the meter prompts, depress the accelerator pedal quickly and continuously but not violently, to reach full fuel position in less than 1 second.</p> <p>Hold it there until a release prompt is given, then immediately release the pedal. Allow the engine, and any turbocharger fitted, to return to idle speed. At the end of the 1st acceleration read the smoke level displayed on the meter. If it is at or</p>	<ol style="list-style-type: none"> <li>1. There must be access to the exhaust tailpipe(s) to allow the insertion of the analyser probe.</li> <li>2. The measured emissions must not exceed the limits, as shown in the table below</li> </ol> <table border="1" data-bbox="1352 655 2125 938"> <thead> <tr> <th data-bbox="1352 655 1632 691">Engine</th> <th colspan="2" data-bbox="1632 655 2125 691">Effective Date</th> </tr> <tr> <td data-bbox="1352 691 1632 762"></td> <th data-bbox="1632 691 1872 762">Before 1<sup>st</sup> July 08</th> <th data-bbox="1872 691 2125 762">1<sup>st</sup> July 08 onwards</th> </tr> </thead> <tbody> <tr> <td data-bbox="1352 762 1632 834">turbocharged engine</td> <td data-bbox="1632 762 1872 834">3.00m<sup>-1</sup></td> <td data-bbox="1872 762 2125 834">1.50m<sup>-1</sup></td> </tr> <tr> <td data-bbox="1352 834 1632 938">non- turbocharged engine</td> <td data-bbox="1632 834 1872 938">2.50m<sup>-1</sup></td> <td data-bbox="1872 834 2125 938">1.50m<sup>-1</sup></td> </tr> </tbody> </table> <ol style="list-style-type: none"> <li>3. The exhaust must not emit excessive smoke or vapour of any colour to an extent likely to obscure the vision of other road users</li> </ol>	Engine	Effective Date			Before 1 <sup>st</sup> July 08	1 <sup>st</sup> July 08 onwards	turbocharged engine	3.00m <sup>-1</sup>	1.50m <sup>-1</sup>	non- turbocharged engine	2.50m <sup>-1</sup>	1.50m <sup>-1</sup>
Engine	Effective Date												
	Before 1 <sup>st</sup> July 08	1 <sup>st</sup> July 08 onwards											
turbocharged engine	3.00m <sup>-1</sup>	1.50m <sup>-1</sup>											
non- turbocharged engine	2.50m <sup>-1</sup>	1.50m <sup>-1</sup>											

## Diesel Emissions 02C

Method of Inspection	Required Standard
<p>below <math>1.50\text{m}^{-1}</math> the vehicle has passed this part of the test and a pass result will be displayed on the meter.</p> <p>If the 1st acceleration smoke level is greater than <math>1.50\text{m}^{-1}</math> carry out two further accelerations following the meter prompts.</p> <p>At the end of the 3rd acceleration, read the mean smoke level displayed on the meter. If it is at or below the appropriate limit, the vehicle has passed this part of the test and a pass result will be displayed on the meter.</p> <p>If the mean smoke level is too high, carry out further accelerations up to a maximum of 6 in total.</p> <p>After each acceleration, check the mean reading. This part of the test is complete when either:</p> <ol style="list-style-type: none"> <li>1. the mean of any 3 consecutive smoke readings is at or below the appropriate limit,</li> <li>2. six accelerations have been performed.</li> </ol> <p>Assess whether the smoke emitted from the exhaust, regardless of measured density, is likely to obscure the vision of other road users.</p> <p>For vehicles with multiple tailpipes linked to separate exhaust systems an average reading should be calculated.</p> <p>Conversions that are not based on M1 vehicles may comply with the applicable requirements of the original base vehicle. Documentary evidence of base or incomplete vehicle approvals will be deemed acceptable, Modification(s) to the exhaust system length after the rear silencer(s) are permissible without further test</p> <p>In the case of a <b>motor caravan, ambulance or hearse</b> the requirements according to the category of the base or incomplete vehicle based on maximum mass may apply. An EC type-approval issued to the most representative base vehicle remains valid irrespective of change in the reference mass.</p> <p>In the case of <b>Armoured</b> vehicles exemption from any requirement of this section is permitted if it can be demonstrated to the satisfaction of the Approval Authority that it is impossible for the vehicle to comply due to its special purpose.</p>	



**Reasons for not carrying out a smoke test.**

Do not carry out a smoke test if the engine is not in a safe condition to do so. This will involve questioning the vehicle presenter and a brief examination of the engine condition. A smoke test must not be carried out if the oil temperature is below 60°C. The reason for not conducting a smoke test must be clearly recorded on the Notification of Refusal (IVA30).

## Record of Revision

Revision	Date	Description of Change
1	27/03/2009	
2	24/05/2010	Add text to clarify that mean value should be calculated for vehicles with multiple exhaust systems, Amended MOI to clarify and align with RVAR 2009
3	28/02/2011	Amend application to remove requirement for mass produced hybrid vehicles
4	03/10/2016	SPV info from section 2B added

## 03A Fuel Tanks

**Application:** All Vehicles

Method of Inspection	Required Standard
<p>This inspection is to ensure that all fuel tanks used to store fuel for the primary propulsion of the vehicle are suitable for their intended use. Taking into account the type of fuel used, the fuel system, including the fuel tank, shall be so designed, constructed and fitted as to withstand the forces, vibration and corrosive environment to which it is likely to be subject. It shall also be so fitted as to avoid the risk of damage, such as abrasion, due to fouling of other parts, and to minimise the risk of fire in the event of any leakage of fuel.</p> <p><b>Fuel Tanks for Gaseous Fuels</b> Check that an Approval / Test Report is presented with the vehicle and that there appears to be no modifications that would invalidate the evidence.</p> <p><b>Note 1:</b> The required standard for Gaseous Fuels: <b>ECE 67.01 – LPG fuel systems</b></p> <ul style="list-style-type: none"> <li>• Recognised as an alternative to the EC Directive on fuel systems in the current ECWVTA Directive and in the Recast Framework Directive. <b>or</b></li> </ul> <p><b>ECE 115.00 – Retrofit LPG fuel systems</b></p> <ul style="list-style-type: none"> <li>• Requires compliance with the installation requirements of ECE 67.01. <b>or</b></li> </ul> <p><b>An Installation Certificate from an Approved Installation Engineer, or</b></p> <p><b>A Comparable Standard for LPG</b> <b>ECE 110.00 – CNG fuel systems</b></p> <ul style="list-style-type: none"> <li>• Recognised as an alternative to the EC Directive on fuel</li> </ul>	<p><b>Fuel Tanks for Gaseous Fuels</b></p> <ol style="list-style-type: none"> <li>1. The vehicle <b>as presented</b> must be accompanied by satisfactory documentary evidence with the required standard for fuel tanks for gaseous fuels (see <b>Note 1</b>)</li> </ol> <p><b>Plastic Fuel Tanks</b></p> <ol style="list-style-type: none"> <li>2. The vehicle must be accompanied by satisfactory evidence that the tank is designed for road use or the fuel tank is an original fitment to a mass produced vehicle, or has been previously and is un-modified. (See <b>Note 2</b>).</li> </ol> <p><b>Fuel Tanks for Liquid fuels at Ambient Temperature</b></p> <ol style="list-style-type: none"> <li>3. A Fuel tank and associated equipment must not leak.</li> <li>4. All fuel related components must be securely mounted.</li> <li>5. All metal fuel tanks must have an earth path to prevent the build up of static electricity. (this may be a separate bonding or the mounting arrangement where it does not isolate the tank)</li> <li>6. A Fuel Tank must be constructed to withstand the environment, forces and vibration it is likely to be subjected to during normal use.</li> <li>7. A Fuel Tank must not be fouled by moving parts of the vehicle, or mounted so that it is likely to be subject to abrasion by adjacent parts.</li> </ol>

## Fuel Tanks 03A

Method of Inspection	Required Standard
<p>systems in the current ECWVTA Directive and in the Recast Framework Directive. <b>or</b></p> <p><b>ECE 115.00 – Retrofit CNG fuel systems</b></p> <ul style="list-style-type: none"> <li>Requires compliance with the installation requirements of ECE 110.00. <b>or</b></li> </ul> <p><b>An Installation Certificate from an Approved Installation Engineer, or</b></p> <p><b>A Comparable Standard for CNG</b> Check that an Approval / Test Report is presented with the vehicle and that there appears to be no modifications that would invalidate the evidence.</p> <p><b>Note 2: Plastic Fuel Tanks</b> Check that the fuel tank:</p> <ul style="list-style-type: none"> <li>Is unmodified and an original fitment in the case of a mass produced vehicle <b>or</b></li> <li>Appears to have previously been fitted to a mass produced vehicle <b>or</b></li> <li>Is accompanied by satisfactory evidence provided by the tank manufacturer or approval authority showing that it has been manufactured and tested to meet the standards required for road use.</li> </ul> <p><b>Fuel Tanks for Liquid Fuels at Ambient Temperature including Additional or Alternative Fuel Tanks.</b> Check the installation of the fuel tank and fuel system components to ensure compliance with the standards.</p>	<ol style="list-style-type: none"> <li>Fuel Tanks must not be positioned near a heat source (similar in installation to that of a type approved vehicle), so that a leak could cause a fire hazard.</li> <li>Fuel Tanks must be positioned so as not to be vulnerable to damage from protruding parts or sharp edges in the event of a front or rear impact.</li> <li>The fuel tank must be positioned so that in the event of a leak the fuel could not accumulate or find a path to the passenger compartment. (if fitted in a compartment there must be a drain which does not exit onto a heat source)</li> <li>A Fuel Tank must not be located in, or form part of the passenger compartment, or other compartment integral with it and the bulkhead that separate the passengers from the fuel tank must be free from holes through which any escaped fuel could travel.</li> <li>The fuel tank must be fitted with a vent (to permit release of a pressure build up) which does not exit on to the exhaust or into the vehicle or be situated at such a height that fuel would be likely to leak when the vehicle is driven.</li> <li>Any fuel filler neck or vent must not allow spilt fuel to be able to fall onto the exhaust system.</li> <li>Fuel tank filling points must not be located in the passenger compartment, luggage compartment or within an engine compartment.</li> <li>A fuel filler cap must positively locate to the filler neck and incorporate an adequate sealing arrangement so that a fuel leak is not possible.</li> <li>The fuel filler cap must either be tethered to the vehicle or be of a lockable type where the key can only be removed when the cap is locked or an automatically opening and closing, non-removable fuel filler cap <b>(Post 0 5 / 2009 vehicles only)</b></li> </ol>

## Fuel Tanks 03A

**Record of Revision**

Revision	Date	Description of Change
1	27/03/2009	
2	31/07/2011	Inserted additional new Note 2 regarding plastic fuel tanks

This page intentionally left blank

## 04 Rear Registration Plate Space

**Application:** All Vehicles

Method of Inspection	Required Standard																			
<p>With an “IVA Test” plate of the required size placed onto the space provided, check that it is visible and can be easily read from a height of 1.5m from all places along a 21.5m line on the ground placed at 10.75m behind and parallel to the rear of the vehicle.</p> <p><b>In the case of unmodified Mass Produced vehicles the standards in this section shall be considered to be met.</b></p> <p><b>Where evidence suggests that the vehicle has been modified, the examiner shall assess whether the modification would be likely to materially affect the performance of the relevant component or system, and if so, carry out assessment against the RS</b></p> <p><b>Note 1:</b> Only Mass Produced vehicles manufactured for the non-European markets may comply with the small space.</p> <p><b>Note 2:</b> A plate hanging from the vehicle with no structure or support brackets behind it would be considered unacceptable</p>	<p>1. All vehicles must comply with one of the registration plate spaces, shown in the table below. (see <b>Note 1</b>)</p> <table border="1" data-bbox="1126 555 2072 730"> <thead> <tr> <th></th> <th></th> <th>Minimum Width MM</th> <th>Minimum Height MM</th> </tr> </thead> <tbody> <tr> <td rowspan="2">Euro space</td> <td>Option 1</td> <td>520</td> <td>120</td> </tr> <tr> <td>Option 2</td> <td>340</td> <td>240</td> </tr> <tr> <td>Small space</td> <td>Option 1</td> <td>300</td> <td>150</td> </tr> <tr> <td></td> <td></td> <td></td> <td></td> </tr> </tbody> </table> <p>2. The space must permit the mounting of a plate in a position as close to vertical as possible taking into account the shape of the bodywork.</p> <p>3. An external body surface or a purpose-designed mounting system securely attached to the vehicle must be provided, to hold the plate in a fixed position. (see <b>Note 2</b>)</p> <p>4. The whole of the yellow shaded portion of the “IVA Test plate” must be capable of being easily seen from every point along the test line.</p>			Minimum Width MM	Minimum Height MM	Euro space	Option 1	520	120	Option 2	340	240	Small space	Option 1	300	150				
		Minimum Width MM	Minimum Height MM																	
Euro space	Option 1	520	120																	
	Option 2	340	240																	
Small space	Option 1	300	150																	

## Rear Registration Plate Space 04

## Record of Revision

Revision	Date	Description of Change
1	27/03/2009	
2	09/04/2009	Text removed from RS4 and added to RS2 "taking into account the shape of the bodywork"



## 05 Steering Effort

**Application:** All Vehicles

Method of Inspection	Required Standard
<p><b>This inspection is to ensure that any Manual or Power Assisted steering system fitted to the vehicle will ensure easy and safe handling of the vehicle up to the maximum design speed of the vehicle.</b></p> <p><b>In the case of unmodified Mass Produced vehicles the standards in this section shall be considered to be met.</b></p> <p><b>Where evidence suggests that the vehicle has been modified, the examiner shall assess whether the modification would be likely to materially affect the performance of the relevant component or system, and if so, carry out assessment against the RS</b></p> <p>With the vehicles steered wheels safely held on turning plates operate the vehicles steering from lock to lock, with and without the power assistance (if fitted). Assess the operation of the system.</p> <p><b>Conversions that are not based on M1 vehicles may comply with the applicable requirements of the original base vehicle. Documentary evidence of base or incomplete vehicle approvals will be deemed acceptable provided the maximum mass of the original approvals has not been exceeded.</b></p> <p>Vehicles fitted with complex drive by wire or hydraulic steering systems cannot be assessed by inspection, therefore documentary evidence must be provided.</p>	<ol style="list-style-type: none"> <li>1. The safe control of the vehicle must not be impaired due to a design or construction feature or characteristic of the steering system.</li> <li>2. The steering must act primarily on the front wheels.</li> <li>3. The steering system must operate smoothly from lock to lock and without undue stiffness with and without power assistance (if fitted).</li> <li>4. The steering angle must not be limited by any part of the steering, transmission or suspension system unless the components have been specifically designed for this purpose</li> <li>5. If the vehicle is fitted with power assisted steering, the steering must still operate with the assistance disabled.</li> <li>6. The steered wheels and tyres must not foul, or be likely to foul other parts of the vehicle under normal operating conditions.</li> <li>7. Steering components must not foul, or be likely to foul other parts of the vehicle under normal operating conditions.</li> <li>8. When the vehicle is driven at speeds above 10mph, there must be a degree of steering "self centring" evident.</li> </ol>

## Steering Effort 05

## Record of Revision

Revision	Date	Description of Change
1	27/03/2009	
2	24/05/2010	Amended and clarified MOI in line with TSE IVA 000M1 05 001, added text relating to vehicles with complex steering systems.
3	17/06/2013	Correction to RS1

## 06 Door Latches and Hinges

**Application:** All Vehicles

Method of Inspection	Required Standard
<p>This inspection applies to doors and to other aperture covers fitted to the vehicle. Compliance may be demonstrated by submission of documentary evidence or an inspection of the vehicle.</p> <p><b>In the case of unmodified Mass Produced vehicles the standards in this section shall be considered to be met.</b></p> <p><b>Where evidence suggests that the vehicle has been modified, the examiner shall assess whether the modification would be likely to materially affect the performance of the relevant component or system, and if so, carry out assessment against the RS</b></p> <p>A <b>side-screen</b> which may be mounted in a structure, and which in either case is <b>hinged</b> to allow entry/ exit and which is <b>permanently secured</b> to the vehicle (i.e. not detachable) is considered to be a door and is subject to the requirements of this section.</p> <p>Doors designed to be easily attached to or removed from a motor vehicle manufactured for operation without doors need only comply with required standard 3</p> <p><b>Note 1:</b> Doors which do not give direct access to seats that are designed for normal use while the vehicle is travelling on the road, i.e. where the longitudinal plane of the most inboard point of the door is more than 300mm from the longitudinal plane of the nearest edge of the seat are exempt from this requirement.</p>	<ol style="list-style-type: none"> <li>1. All driver and passenger doors fitted to the sides of the vehicle must have a latch mechanism with both intermediate and fully latched positions. Alternatively, doors must be fitted with a safety bolt and an audible warning device, which activates when the vehicle is being driven if the bolt is not in the “secured” position (see <b>Note 2</b>).</li> <li>2. All driver and passenger hinged doors must have a latch mechanism that will withstand a load which is likely to be applied in normal driving conditions, in both intermediate and fully latched positions, unless fitted with a safety bolt and audible warning device where it will only need to meet this requirement in the secured (locked) position (see <b>Notes 1 and 2</b>).</li> <li>3. Hinge-mounted side doors (excluding gullwing and bus type folding doors) must hinge from the front of the door in relation to the direction of forward travel(see <b>Note 3</b>),</li> <li>4. Gullwing or suicide doors fitted to the sides of the vehicle must be             <ol style="list-style-type: none"> <li>a. fitted with a device that automatically moves the door to the closed or intermediate latched position if unlatched when the vehicle is moving forward,</li> </ol> <p>or</p> <ol style="list-style-type: none"> <li>b. fitted with a safety bolt and an audible warning device, that activates when the vehicle is being driven if the bolt is not in the “secured” position.</li> </ol> </li> </ol>

## Door Latches and Hinges 06

Method of Inspection	Required Standard
<p><b>Note 2:</b> Any power operated door where force applied by the power actuator is sufficient to keep the door completely closed even when any load is applied is exempt from this requirement.</p> <p><b>Note 3:</b> Overlapping double doors are deemed to comply with required standard 3 provided that the front door overlaps the rear door when closed. Suicide doors will not comply with required standard 3 but are permitted if they comply with required standard 4.</p> <p><b>Note 4:</b> There is no requirement for an interior operating control on any access door behind the driver or front passenger seats</p> <p><b>Door</b> Means a hinged or sliding door which leads directly into a compartment that contains one or more seating positions.</p> <p><b>Gullwing door</b> A door that hinges from top of the door aperture.</p> <p><b>Suicide Door</b> A door that hinges from the rear of the door aperture.</p>	<ol style="list-style-type: none"> <li>5. All doors intended for passenger use must provide an adequate opening to enable safe access to and from the vehicle.</li> <li>6. Where a vehicle is fitted with doors all the edges of the apertures (with the door open) that are contactable with a 100mm diameter sphere must be at least blunted.</li> <li>7. All front passenger doors must be fitted with internal operating controls which are accessible from the adjacent seating position (see <b>Note 4</b>).</li> <li>8. All aperture covers must secure in the fully closed position.</li> </ol>

## Door Latches and Hinges 06

## Record of Revision

Revision	Date	Description of Change
1	27/03/2009	
2	09/04/2009	RS2 reworded to exclude the need to test latch mechanism to 30kgf
3	24/05/2010	Amended wording of RS3, RS4 and added note 5
4	01/09/2012	Reword RS5, RS7 and add note to RS7
5	17/06/2013	Reword Mol paragraph 4, remove numbering from notes 1 & 2, reformat remainder of notes & insert definition of doors.

This page intentionally left blank

## 07 Audible Warning

**Application:** All Vehicles

Method of Inspection	Required Standard
<p>Ensure that the vehicle is fitted with a horn which when operated emits a continuous uniform sound that is capable of giving audible warning of the approach or position of the vehicle to which it is fitted.</p> <p><b>In the case of unmodified Mass Produced vehicles the standards in this section shall be considered to be met.</b></p> <p><b>Where evidence suggests that the vehicle has been modified, the examiner shall assess whether the modification would be likely to materially affect the performance of the relevant component or system, and if so, carry out assessment against the RS</b></p> <p>In the case of <b>Armoured</b> vehicles exemption from RS 3 and 4 of this section is permitted if it can be demonstrated to the satisfaction of the Approval Authority that it is impossible for the vehicle to comply due to its special purpose.</p> <p><b>Note 1:</b> For the purposes of this item "horn" means an audible warning device not being a bell, gong or siren.</p>	<ol style="list-style-type: none"> <li>1. The vehicle must be fitted with a horn</li> <li>2. The horn must be secure</li> <li>3. The horn must emit a continuous uniform sound.</li> <li>4. The horn must perform to an equivalent level of an EC Type Approved vehicle</li> </ol>

## Audible Warning 07

## Record of Revision

Revision	Date	Description of Change
1	27/03/2009	
2	31/07/2011	Restricted exemption for <b>Armoured</b> vehicles to RS 3 & 4 only



## 08 Indirect Vision

**Application:** All Vehicles

Method of Inspection	Required Standard
<p>This inspection is to ensure that obligatory mirrors/camera systems meet the appropriate safety standards and offer an acceptable standard of rearward vision.</p> <p>Camera systems will only be required to meet RS4, RS6 and RS12.</p> <p>In the case of <b>Armoured</b> vehicles exemption from any requirement of this section is permitted if it can be demonstrated to the satisfaction of the Approval Authority that it is impossible for the vehicle to comply due to its special purpose.</p> <p><b>Note 1:</b> All obligatory mirrors fitted to the vehicle are as follows</p> <ol style="list-style-type: none"> <li>1. One interior mirror of Class I</li> <li>2. One exterior mirror on the offside of Class III or Class II.</li> </ol> <p><b>Note 2:</b> These dimensions are the minimum requirements of the reflective surface and not the overall size of the mirror assembly.</p> <p><b>Note 3:</b> The interior mirror must be positioned as far as is practical to afford the best possible view to the rear, if the interior rear-view mirror does not provide any rearward vision its presence shall not be required.</p> <p><b>Note 4:</b> All components must be attached by a method normally used by a major manufacturer; components attached by suction are not permitted.</p>	<ol style="list-style-type: none"> <li>1. The vehicle must have an offside exterior mirror fitted.</li> <li>2. An interior mirror must be fitted, (see <b>Note 3</b>)</li> <li>3. The vehicle must have an nearside exterior mirror fitted (if the interior rear view mirror gives no view to the rear or the rear window is less than 70% light transmittance) (see <b>Notes 3 &amp; 5</b>)</li> <li>4. All obligatory mirrors/camera systems must be securely mounted to the vehicle, to ensure that the field of view does not change. (see note 4)</li> <li>5. <b>All</b> mirrors must be adjustable.</li> <li>6. Obligatory mirrors/camera systems must be mounted so as to prevent the driver misinterpreting the image because of vibration.</li> <li>7. <b>All</b> mirrors must have an acceptable approval marking <b>or</b> have equivalent characteristics to a mirror approved for use on a vehicle of the same category as follows: <ul style="list-style-type: none"> <li>• The reflective surface must be encased in a protective housing</li> <li>• surfaces contactable by a 165mm sphere (interior) or a 100mm sphere (exterior) must have a radius of curvature of at least 2.5mm – except for fixing holes or recesses less than 12mm wide, which must be blunted</li> </ul> </li> </ol>

## Indirect Vision 08

Method of Inspection	Required Standard
<p><b>Note 5:</b> If the vehicle has a rear view window fitted which is less than 70% light transmittance (marked with a V) a nearside exterior mirror is required.</p> <p><b>Note 6:</b> If fitted, an optional nearside mirror may supplement the field of view requirements of the obligatory mirrors</p>	<ol style="list-style-type: none"> <li>8. An interior mirror must be a minimum of 40mm high by 80mm long (see <b>Note 2 &amp; Figure 1</b>)</li> <li>9. An exterior mirror must be a minimum of 40mm high and 70mm long, <b>and</b> be able to incorporate a measurement parallel to the height of the rectangle at least 70mm in length within the lens. (see <b>Note 2 &amp; Figure 1</b>)</li> <li>10. The interior mirror must be adjustable from the normal driving position.</li> <li>11. The obligatory offside mirror fitted to a vehicle with a right hand or central driving position must be adjustable from the driving seat. Alternatively, if knocked out of alignment, it must be capable of being returned to its former position without the need for adjustment.</li> <li>12. An obligatory mirror or camera system must provide the required field of view (see <b>Annex 1</b> and <b>Note 6</b>).</li> </ol>

**Figure 1**

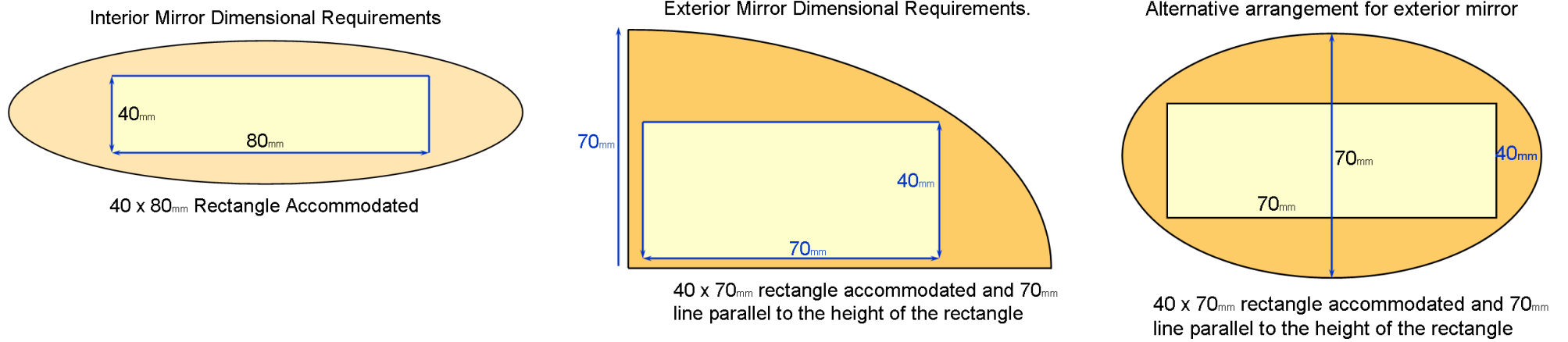

## Annex 1: Mirror Field of View Check

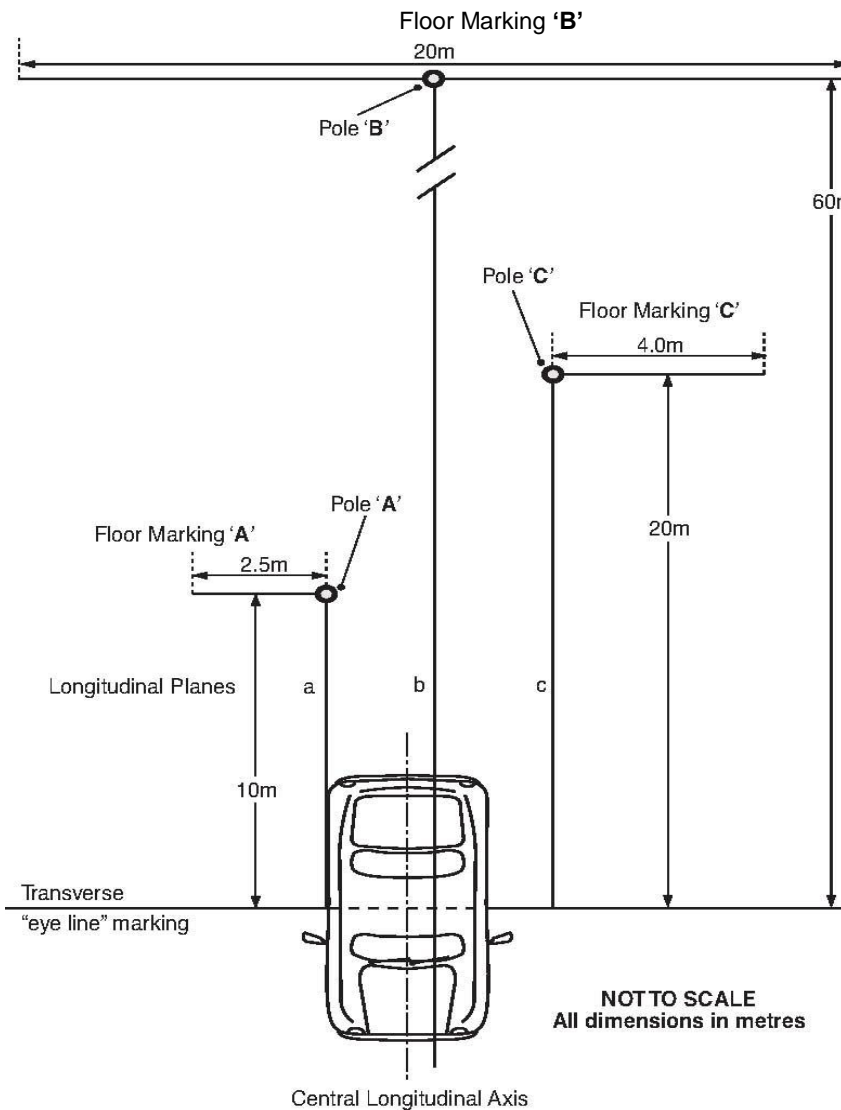

With a pole positioned vertically at the junction of lines 'a' and 'A' in respect of the offside exterior mirror; 'b' and 'B' in respect of the interior mirror; and where required, (see note 2) 'c' and 'C' in respect of the nearside exterior mirror, mark each pole (A, B and C) to show the height of the upper edge of the corresponding mirror reflective surface (the "mirror dimension").

In cases where the driver's seat is adjustable, position the seat in the rearmost position.

When seated in the driver's seat looking ahead and in a comfortable upright driving position, align the vehicle such that your eye position is vertically aligned with the transverse floor "eye-line" marking and;

1. the offside extreme outer edge of the vehicle is positioned along line 'a'; check that up to the height of the "mirror dimension" on pole 'A' and the whole of the floor marking 'A' is visible in the offside exterior mirror (see note 1);
2. the longitudinal centre line of the vehicle is positioned along line 'b'; check that up to the height of the "mirror dimension" on pole 'B' and the whole of the floor marking 'B' is visible in the interior mirror (see note 1);
3. (where required) the nearside extreme outer edge of the vehicle is positioned along line 'c'; check that up to the height of the "mirror dimension" on pole 'C' and the whole of the floor marking 'C' is visible in the nearside exterior mirror (see note 1).

**NOTE 1:** While sitting in the driving position, facing forward, the respective field of view in each mirror should be obtainable by pivoting the eyes/head, without bodily movement.

**NOTE 2:** Obstruction by the vehicle's bodywork and other components fitted to the vehicle in the case of an interior mirror of 15% and in the case of an exterior mirror 10% is permitted

**NOTE 3:** If an interior mirror does not provide the required field of view, a nearside exterior mirror meeting the appropriate field of view requirement must be fitted.

NOT TO SCALE  
All dimensions in metres

## Annex 2

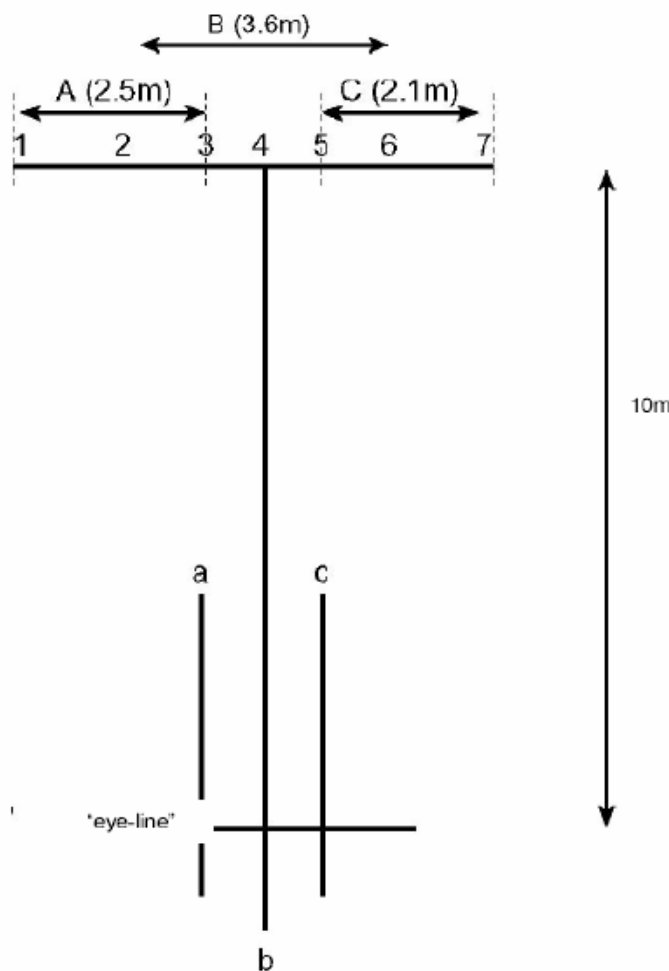

## Position poles and “flags”

With a pole positioned vertically at the floor marking 3 in respect of the offside exterior mirror; 4 in respect of the interior mirror; and where required, (see note 3) 5 in respect of the nearside exterior mirror, mark poles 3, 4, and 5 to show the height of the upper edge of the corresponding mirror reflective surface (the “mirror dimension”). Using the chart shown above, by reference to the “mirror dimension” (column X) obtain the interior mirror lower marker height (column Y) and mark a horizontal line on poles 2, 4 and 6 at the given height. Where required, (see note 3) obtain the nearside mirror lower marker height (column Z) and mark horizontal line on poles 5 and 7 at the given height.

In cases where the driver’s seat is adjustable, position the seat in the rearmost position. When seated in the driver’s seat looking ahead and in a comfortable upright driving position, align the vehicle such that your eye position is vertically aligned with the transverse floor “eye-line” marking and with the offside extreme outer edge of the vehicle positioned along line ‘a’; check that up to the height of the “mirror dimension” on pole 3 and the whole of the floor marking 1 to 3 is visible in the offside exterior mirror (see note 1 & 2).

The longitudinal centre line of the vehicle positioned along line ‘b’; check that the section of pole 4 between the upper (“mirror dimension”) marker and the lower marker, and the whole of the horizontal line formed between poles 2, 4 and 6 is visible in the interior mirror (see notes 1, 2 & 3).

The nearside extreme outer edge of the vehicle (where required) positioned along line ‘c’; check that the section of pole 5 between the upper (“mirror dimension”) marker and the lower marker, and the whole of the horizontal line formed between poles 5 and 7 is visible in the nearside exterior mirror (see notes 1, 2 & 3);

**NOTE 1:** While sitting in the driving position, facing forward, the respective field of view in each mirror should be obtainable by pivoting the eyes/head, without bodily movement.

**NOTE 2:** Obstruction by the vehicle’s bodywork and other components fitted to the vehicle in the case of an interior mirror of 15% and in the case of an exterior mirror 10% is permitted

**NOTE 3:** If an interior mirror does not provide the required field of view, a nearside exterior mirror meeting the appropriate field of view requirement must be fitted.

## Indirect Vision 08

(Y) Interior Mirror Marker Lower Height (mm)	(X) Height To Top Of Lens (mm)	(Z) Nearside Mirror Marker Lower Height (mm)
1230	1500	713
1222	1490	708
1214	1480	703
1205	1470	698
1197	1460	694
1189	1450	689
1181	1440	684
1173	1430	679
1164	1420	675
1156	1410	670
1148	1400	665
1140	1390	660
1132	1380	656
1123	1370	651
1115	1360	646
1107	1350	641
1099	1340	637
1091	1330	632
1082	1320	627
1074	1310	622
1066	1300	618
1058	1290	613
1050	1280	608
1041	1270	603
1033	1260	599
1025	1250	594
1017	1240	589
1009	1230	584
1000	1220	580
992	1210	575
984	1200	570
976	1190	565
968	1180	561
951	1160	551

(Y) Interior Mirror Marker Lower Height (mm)	(X) Height To Top Of Lens (mm)	(Z) Nearside Mirror Marker Lower Height (mm)
943	1150	546
935	1140	542
927	1130	537
918	1120	532
910	1110	527
902	1100	523
894	1090	518
886	1080	513
877	1070	508
869	1060	504
861	1050	499
853	1040	494
845	1030	489
836	1020	485
828	1010	480
820	1000	475
812	990	470
804	980	466
795	970	461
787	960	456
779	950	451
771	940	447
763	930	442
754	920	437
746	910	432
738	900	428
730	890	423
722	880	418
713	870	413
705	860	409
697	850	404
689	840	399
681	830	394
672	820	390

(Y) Interior Mirror Marker Lower Height (mm)	(X) Height To Top Of Lens (mm)	(Z) Nearside Mirror Marker Lower Height (mm)
664	810	385
656	800	380
648	790	375
640	780	371
631	770	366
623	760	361
615	750	356
607	740	352
599	730	347
590	720	342
582	710	337
574	700	333
566	690	328
558	680	323
549	670	318
541	660	314
533	650	309
525	640	304
517	630	299
508	620	295
500	610	290
492	600	285
484	590	280
476	580	276
467	570	271
459	560	266
451	550	261
443	540	257
435	530	252
426	520	247
418	510	242
410	500	238

**NOTE:** Where the “mirror dimension” is outside the scope of this table the lower marker height for the

- Interior Mirror = “mirror dimension” (height to top of lens) x 82%
- Nearside Mirror = “mirror dimension” (height to top of lens) x 47.5%

## Mirror field of View – Alternative Test procedure

### Pole and Marker Positions

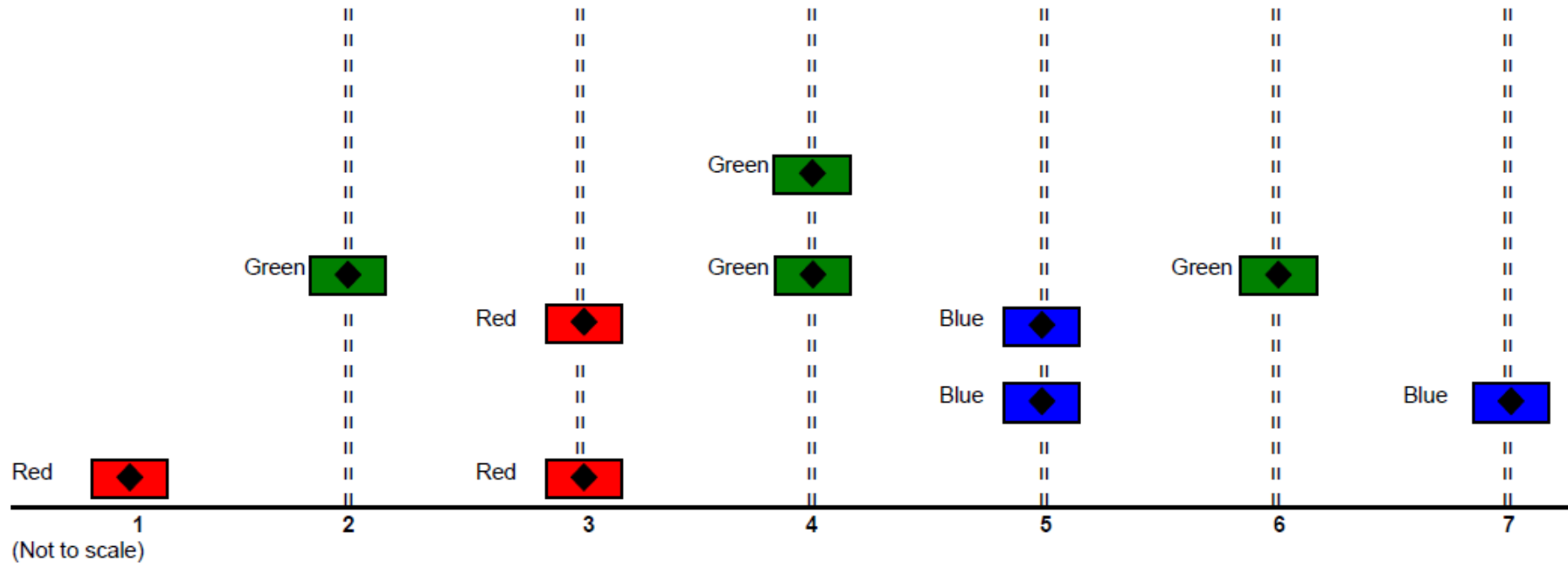

**Offside Mirror** (red markers) - Pole 3 in line with mirror test area line "a", and marker 1 outer edge placed 2.5 metres from pole 3.

**Interior Mirror** (green markers) - Pole 4 placed on mirror test area centre line "b", and Poles 2 and 6 placed 1.8 metres either side of pole 4.

**Nearside Mirror** (blue markers) (where required) - Pole 5 in line with mirror test area line "c" and pole 7 placed 2.1 metres from pole 5.

## Indirect Vision 08

## Record of Revision

Revision	Date	Description of Change
1	27/03/2009	
2	09/04/2009	Figure 1 added
3	29/06/2009	Note added for the use of the optional nearside mirror in conjunction with field of view
4	24/05/2010	Removed reference to Hearse, Motor Caravan and ambulance and as it is not in RVAR 2009. RS8 removed as it contradicts specific exemption in RVAR for all types of vehicle not just LHD
5	28/02/2011	Correct numbering of alternative test procedure diagram
6	03/10/2016	Incorporate camera systems, clarify Note 2 in Annexes 1 & 2



## 09A Brake Systems

**Application:** Vehicles subject to Basic requirements

Method of Inspection	Required Standard
<p>Ensure that all vehicles are fitted with braking systems capable of stopping the vehicle in a safe controlled manner and prevent the vehicle from moving without the control of the driver. The systems must be correctly constructed allowing for ageing, corrosion and the stresses to which the system that will be subjected</p> <p>Conversions that are not based on M1 vehicles may comply with the applicable requirements of the original base vehicle. Documentary evidence of base or incomplete vehicle approvals will be deemed acceptable provided the maximum mass of the original approvals has not been exceeded.</p> <p><b>Note 1:</b> The secondary system can be either one half of the split system (following failure of the other half) or secondary can be on the handbrake (Secondary/Park).</p>	<p><b>Service</b></p> <ol style="list-style-type: none"> <li>1. The vehicle must be fitted with a service braking system that is completely independent of the control of the parking brake, capable of functioning on all wheels by a single means of operation, which will gradually increase or reduce the braking force through action of the control.</li> <li>2. The 'service' braking system must be capable of being operated from the driving seat, whilst keeping both hands on the steering wheel. This does not apply to the controls for use by a disabled driver, providing the adaptation allows him/her to control the steering at all times while operating either braking system.</li> <li>3. The 'service' braking system must be capable of being operated to slow down the vehicle when it is moving in a forward or reverse direction.</li> <li>4. The vehicle must be fitted with a split (dual) circuit brake system with each part of the system operating on at least two wheels (one on each side), capable of operating in the event of a failure of the service brake or its power assistance.</li> </ol> <p><b>Secondary</b></p> <ol style="list-style-type: none"> <li>5. The vehicle must be fitted with a secondary system, capable of operating in the event of a failure of the service brake or its power assistance See <b>Note 1</b></li> </ol>

## Brake Systems 09A

Method of Inspection	Required Standard
	<p data-bbox="1149 231 1261 263"><b>Parking</b></p> <ol data-bbox="1198 295 2116 805" style="list-style-type: none"><li data-bbox="1198 295 2116 399">6. The 'parking' braking system must be capable of being operated from the driving seat, whilst keeping one hand on the steering wheel.</li><li data-bbox="1198 430 2116 502">7. The 'parking' braking system must be capable of being operated and released whether the vehicle is stationary or moving.</li><li data-bbox="1198 534 2116 638">8. The 'parking' braking system must be capable of being operated on all wheels of at least one axle enabling the vehicle to be held on an up or down gradient even in the absence of the driver.</li><li data-bbox="1198 670 2116 805">9. The 'parking' braking system must be capable of being operated using a control which is independent of the service brake, and once applied capable of being maintained in the 'on' position solely by mechanical means.</li></ol>

## Record of Revision

Revision	Date	Description of Change
1	27/03/2009	
2	24/05/2010	Clarified MOI in line with TSE IVA 000M1 05 001

This page intentionally left blank

## 09B Service Brake Control / Mechanical Components

**Application:** Vehicles subject to Basic requirements

Method of Inspection	Required Standard
<p>All vehicles including a Disabled Person's vehicle where any adaptation or part of the system affected by an adaptation is subject to the requirements of this section. All service brake controls must operate in a forward direction i.e. in the direction of the force acting upon the driver as a result of the braking effort, when the vehicle is travelling in a forward direction; this is to ensure that under braking the brake is likely to remain applied. (Monotonic function)</p> <p>All components must be capable of withstanding the stresses, vibration, corrosion, and ageing (allowing for routine maintenance) to which they may be subject.</p> <p><b>Note 1:</b> Fully apply the control twice, first slowly and then rapidly each time to a point where sustained pressure can be held.</p> <p><b>Note 2:</b> Utilizing only the tools or equipment normally supplied with the vehicle; for instance, by the provision of appropriate inspection holes or by some other means. The removal of front and/or rear wheels is permitted for this purpose, Alternatively, acoustical or optical devices warning the driver at his driving position when lining replacement is necessary are acceptable.</p> <p><b>Note 3:</b> If a vacuum servo is fitted, with the engine off, totally deplete the stored vacuum. Fully apply the service brake. Note whether the control can be felt to travel further when the engine is started. If operation is not detected, the vehicle should be re-checked with the brake partially applied</p>	<ol style="list-style-type: none"> <li>1. The brake control must be capable of being operated easily from the driving position without obstruction or abnormal hand/foot position and that the pedal (where fitted) has an anti-slip provision.</li> <li>2. All service brake controls must operate in the same direction as the forces created when the vehicle is in forward direction.</li> <li>3. A brake control, actuating linkage or associated component must be fully accessible for maintenance purposes.</li> <li>4. A brake control, actuating linkage or associated component must be complete, so that it functions correctly.</li> <li>5. A brake control, actuating linkage or associated component must be of adequate strength so as not to be likely to fail prematurely.</li> <li>6. A brake control, actuating linkage or associated component must be made of a material sufficiently durable so as not to be likely to fail prematurely.</li> <li>7. A brake control, actuating linkage or associated component must not be obstructed in its travel or foul parts of the vehicle.</li> <li>8. A brake control, actuating linkage or associated component mounting/bracket must be of adequate strength so as not to be likely to fail prematurely</li> </ol>

## Service Brake Control / Mechanical Components 09B

Method of Inspection	Required Standard
<p><b>Note 4:</b> Hydraulic valves that only operate automatically and react to vehicle loading or braking forces are permitted (Load Sensing and Gravity valves) Manually adjusted valves (other than to permit presetting the automatic function of a valve) are not permitted to be fitted even if they are rendered un-adjustable.</p> <p><b>Note 5:</b> Bias bars and other mechanical adjusting devices fitted to twin master cylinders must be rendered inoperable by mechanical means e.g. lock wiring of components.</p> <p><b>Note 6:</b> Adjusting front/rear brake bias may invalidate approval and breach Construction and Use requirements.</p>	<p><b>9.</b> A brake control, actuating linkage or associated component mounting/bracket must be secure to the vehicle structure.</p> <p><b>10.</b> A brake control, actuating linkage or associated component mounting/bracket securing method must be of adequate strength so as not to be likely to fail prematurely.</p> <p><b>11.</b> A brake control, actuating linkage or associated component pivot bearing/bush must be of adequate strength so as not to be likely to fail prematurely</p> <p><b>12.</b> A brake control, actuating linkage or associated component pivot bearing/bush must be secure such that it is unlikely to become displaced.</p> <p><b>13.</b> Any brake control, actuating linkage or associated component pivot/linkage pins must be present and secure.</p> <p><b>14.</b> Any brake control, actuating linkage or associated component locking/retaining devices must be present and secure.</p> <p><b>15.</b> With the brake control fully applied there must be sufficient reserve travel. See <b>Note 1</b></p> <p><b>16.</b> The brake control must not creep down while it is held under pressure. See <b>Note 1</b></p> <p><b>17.</b> There must not be an indication of 'sponginess' when the brake control is operated, indicating air in the system. See <b>Note 1</b></p> <p><b>18.</b> When the brake control is applied (following vacuum depletion) and the engine started a dip must be felt, indicating that vacuum assistance is working satisfactorily. See <b>Note 3</b></p>

## Service Brake Control / Mechanical Components 09B

Method of Inspection	Required Standard
	<p><b>19.</b> On a <b>full power hydraulic braking system</b> a warning device must be fitted, operative, and visible or audible to the driver, including in darkness.</p> <p><b>20.</b> All brake mechanical components must be secure, with relevant securing bolts, locking devices, retaining device etc present and secure.</p> <p><b>21.</b> A brake assembly on a <b>FRONT</b> axle of a vehicle must incorporate an automatic means of compensating for friction material wear.</p> <p><b>22.</b> A brake assembly on a <b>REAR</b> axle of a vehicle must incorporate an automatic or manual means of compensating for friction material wear.</p> <p><b>23.</b> The brake friction surfaces must have sufficient capacity to dissipate heat and prevent fade.</p> <p><b>24.</b> It must be possible to easily check the wear on service brake linings, from the outside or underside of the vehicle, See <b>Note 2</b></p> <p><b>25.</b> All braking controls must apply and release the relevant brakes at a rate comparable to that of an approved system.</p> <p><b>26.</b> It must not be possible to manually adjust braking rates between axles see <b>Notes 4 and 5</b></p> <p><b>27.</b> Vehicles fitted with adjustable twin master cylinders that have been rendered inoperable by mechanical means to comply with RS 26 must have a label affixed on the master cylinder or the immediate vicinity with legible text as detailed in <b>Note 6</b>.</p>

## Service Brake Control / Mechanical Components 09B

## Record of Revision

Revision	Date	Description of Change
1	27/03/2009	
2	24/05/2010	Clarified MOI in line with TSE IVA 000M1 05 001, amended note 5, added note 6 and RS27.

## Service Brake Control / Mechanical Components 09B



## 09C Park Brake Control / Mechanical Components

**Application:** Vehicles subject to Basic requirements

Method of Inspection	Required Standard
<p>The park brake lever needs to be checked throughout its operating range,</p> <p><b>Note 1:</b> Parking brake reserve travel and locking positions are required to allow components such as brake cables to stretch without diminishing park brake performance.</p>	<ol style="list-style-type: none"> <li>1. A parking brake lever, actuating linkage, cable or associated component must be complete so that it functions correctly</li> <li>2. A parking brake lever, actuating linkage, cable or associated component must be of adequate strength so as not to be likely to fail prematurely</li> <li>3. A parking brake lever, actuating linkage, cable or associated component must be made of a material sufficiently durable so as not to be likely to fail prematurely</li> <li>4. A parking brake lever, actuating linkage, cable or associated component must not be obstructed in its travel nor foul parts of the vehicle</li> <li>5. A parking brake lever, actuating linkage, cable or associated component mounting / bracket must be secure to the vehicle structure</li> <li>6. A parking brake lever, actuating linkage, cable or associated component mounting / bracket securing method must be of adequate strength so as not to be likely to fail prematurely</li> <li>7. A parking brake lever, actuating linkage, cable or associated component pivot bearing / bush must be of adequate strength so as not to be likely to fail prematurely</li> </ol>

## Park Brake Control / Mechanical Components 09C

Method of Inspection	Required Standard
	<ol style="list-style-type: none"> <li data-bbox="1198 236 2049 331">8. A parking brake lever, actuating linkage, cable or associated component pivot bearing / bush must be secure such that it is unlikely to become displaced</li> <li data-bbox="1198 371 2033 435">9. A parking brake lever, actuating linkage, cable or associated component pivot / linkage pins must be present and secure</li> <li data-bbox="1198 475 2110 539">10. A parking brake lever, actuating linkage, cable or associated component locking / retaining devices must be present and secure</li> <li data-bbox="1198 579 2065 643">11. The parking brake ratchet pawl must engage positively with the ratchet teeth</li> <li data-bbox="1198 683 2116 746">12. A hand lever operated parking brake must not disengage when the lever is knocked on each side and on the top.</li> <li data-bbox="1198 786 2033 850">13. A lever operated parking brake when fully applied must have reserve travel and locking positions (see <b>Note 1</b>)</li> <li data-bbox="1198 890 2072 1018">14. An electrically operated parking brake switch must be protected from inadvertent use. As an alternative, with the ignition off, the switch must be capable of applying the brake, but must not be capable of releasing the brake.</li> <li data-bbox="1198 1058 2123 1121">15. The parking brake mechanism must incorporate a means of manual or automatic adjustment to compensate for wear.</li> </ol>

## Park Brake Control / Mechanical Components 09C

## Record of Revision

Revision	Date	Description of Change
1	27/03/2009	
2	24/05/2010	Amend wording of RS 13 in line with IVA 000M1 09 003 and add note 1 to clarify intention.
3	31/10/2011	Amend wording of RS 15 to correct compensation requirement

## Park Brake Control / Mechanical Components 09C

This page intentionally left blank

## 09D Hydraulic and Vacuum Systems

**Application:** Vehicles subject to Basic requirements

Method of Inspection	Required Standard
<p>Where practicable, check all hydraulic and vacuum components for suitability of design, construction methods and materials, location, and mountings/fixings to the vehicle structure or other components.</p> <p>All components must be suitable to withstand the stresses, vibration, corrosion and ageing (allowing for routine maintenance) to which they may be subject.</p> <p>Compression joints of the type using separate ferrules are not considered suitable for joints on hydraulic brake lines other than in the case of a hose designed for a high pressure application that incorporates an inner sleeve in the compression fitting.</p> <p><b>Note 1:</b> Check for leaks in any part of the braking system, with or without the brake applied. For vehicles fitted with a vacuum servo or power braking system, the engine must be running during the inspection.</p> <p><b>Note 2:</b> in the case of a conventional split system (with or without vacuum assistance) it will be assumed that a failure will result in the draining of the fluid. It may be necessary to confirm the fluid circuit through the master cylinder by documentary evidence.</p> <p><b>Note 3:</b> One reservoir fluid warning lamp may fulfil the function of checking the fluid level (RS 18) and monitoring the hydraulic system (RS 19) providing both criteria are met.</p>	<ol style="list-style-type: none"> <li>1. A hydraulic and vacuum component must be complete, so that it functions correctly.</li> <li>2. A hydraulic and vacuum component must be of adequate strength so as not to be likely to fail prematurely</li> <li>3. A hydraulic and vacuum component must be made of a material sufficiently durable so that it is unlikely to fail prematurely.</li> <li>4. A hydraulic and vacuum component mounting/bracket must be secure to the vehicle structure or other components</li> <li>5. A hydraulic and vacuum component mounting/bracket must be of adequate strength so as not to be likely to fail prematurely.</li> <li>6. A hydraulic and vacuum component mounting/bracket securing method must be of adequate strength and unlikely to fail prematurely.</li> <li>7. A brake pipe or hose must not be fouled by moving parts</li> <li>8. A brake pipe or hose must not be kinked, stretched, or twisted.</li> <li>9. A brake pipe or hose must be adequately clipped or otherwise supported.</li> <li>10. A brake pipe or hose must have suitable joint fittings</li> </ol>

## Hydraulic and Vacuum Systems 09D







Method of Inspection			Required Standard
<p>Figure 1</p> 			<p>11. A brake pipe or hose must not be exposed to excessive heat.</p> <p>12. A hydraulic/vacuum component must not be subject to a corrosive environment and likely to fail prematurely.</p> <p>13. Components must not leak. (see <b>Note 1</b>)</p> <p>14. A fluid reservoir filling port must be easily accessible</p> <p>15. A fluid reservoir cap must be present and secure.</p> <p>16. It must be possible to check the fluid relative to the manufacturer's specified minimum level on all brake fluid reservoirs by the actual fluid level being visible through a transparent section of the reservoir, with the minimum level marked permanently on to this section. As an alternative, a red warning lamp (see <b>Figure 1</b>) must be capable of illuminating when the reservoir fluid falls to the minimum level.</p> <p>17. An indelible label must be affixed in a visible position within 100 mm of the filling ports of the fluid reservoirs to ensure that it is possible for the end user of the vehicle to identify the brake fluid used in braking system. DOT fluid references and/or the Symbols and text in <b>Table 1</b> are considered acceptable.</p> <p>18. Where a warning lamp is provided as the only means of checking the fluid level without opening the reservoir, it must be secure, operational, visible during daylight and darkness from the driving position, and fitted with a "test facility" that enables its operation to be checked from the driving position without opening the reservoir.</p>
<b>Glycol based brake fluid</b>	 	<p><b>DOT 3</b> <b>DOT 4</b> <b>DOT 5.1</b></p>	
<b>Mineral based brake fluid</b>	 		
<b>Silicone based brake fluid</b>		<p><b>DOT 5</b></p>	

Table 1

## Hydraulic and Vacuum Systems 09D

Method of Inspection	Required Standard
<p><b>Note 4:</b> The vehicle must be driven and the operation (modulation) of the ABS system assessed under braking to indicate satisfactory operation of the system. NB This check is not necessary if the ABS warning lamp illuminates during a speedometer check indicating that the sensors are detecting unusual wheel speeds/operation.</p>	<p><b>19.</b> The hydraulic system must be fitted with a red warning lamp, sensitive to line pressure and capable of signalling the failure of any part of the hydraulic system as soon as the brake is applied and remaining lit as long as the failure exists (with the ignition switched on). As an alternative, the warning lamp must be sensitive to the reservoir fluid level, providing the reservoir is directly connected to supply the pressure side of the master cylinder when the piston is in the “brakes off” position, so that a failure of either part of a split system would result in a continuous draining of the reservoir fluid when the control is released (see <b>Notes 2</b> and <b>3</b>).</p> <p><b>20.</b> The hydraulic system failure warning lamp must be secure, operational, visible during daylight and darkness from the driving position, identifiable (i.e. labelled in a recognised form – see figure 1 for an example) and fitted with a “test facility” that enables its operation to be checked from the driving position without opening the reservoir.</p> <p><b>21.</b> If the vehicle is fitted with an anti-lock braking system, all components must be present, undamaged, secure, connected and operational so that the system is likely to function as intended. See <b>Note 4</b></p> <p><b>22.</b> If the vehicle is fitted with an anti-lock braking system an operational warning lamp must be fitted to monitor the system, visible from the driving position, which operates when the anti-lock is energised, and extinguishes at the latest when the vehicle speed reaches 10km/h</p>

## Hydraulic and Vacuum Systems 09D

## Record of Revision

Revision	Date	Description of Change
1	27/03/2009	
2	24/05/2010	Amend wording of RS17 and add table 1 in line with TSE IVA M1 09 005



## 09E Brake Performance

**Application:** Vehicles subject to Basic requirements

Method of Inspection	Required Standard
<p>All vehicles including a Disabled Person's vehicle where any adaptation or part of the system affected by an adaptation is subject to the requirements of this sub-section and must meet the required standards.</p> <p>All brake efficiencies are calculated using the vehicle CLW or DGW (where available) whichever is the higher value as determined in section 44</p> <p>All braking systems when operated must react at a speed comparable to systems fitted to an Approved vehicle. This is particularly relevant to delay of service brake operation with alternative systems such as remotely applied electric motors etc.</p> <p><b>Roller brake tester –</b></p> <p>Certain vehicles must not be tested on a roller brake tester:</p> <ol style="list-style-type: none"> <li>a. vehicles with more than one driving axle permanently engaged</li> <li>b. vehicles with belt driven transmission</li> <li>c. vehicles with brakes for which the servo only operates when the vehicle is moving.</li> </ol> <p>These vehicles should be tested using a decelerometer.</p> <p>The engine must be idling when conducting the roller brake test for all vehicles fitted with a servo or full power hydraulic braking systems except for the brake distribution test (Standard 10), the depleted servo test (Standard 11) and the power hydraulic test (Standard 12).</p>	<p><b>Roller Brake Test</b></p> <ol style="list-style-type: none"> <li>1. A low braking effort must not be recorded from any wheel, indicating clearly that the brake is not functioning correctly.</li> <li>2. The service brake performance must be at least 60%, (of the CLW or DGW as determined to be the highest) or more than half the road wheels lock.</li> <li>3. The secondary brake performance must be at least 25%,(of the CLW or DGW as determined to be the highest) for: <ul style="list-style-type: none"> <li>• each half of the split system <b>or</b></li> <li>• the park brake if used as secondary. (see <b>Note 6</b>)</li> </ul> </li> <li>4. A significant braking effort must not be recorded from a road wheel without application of the brakes, indicating brake bind.</li> <li>5. There must be no evidence of severe brake grab or judder as the brake is applied.</li> <li>6. The braking efforts at the road wheels must increase progressively at about the same rate when the service brake is applied gradually.</li> <li>7. The braking efforts at the road wheels must reduce at about the same rate when the service brake is released gradually.</li> </ol>

## Brake Performance 09E

Method of Inspection	Required Standard
<p>In some cases it may be necessary to chock the wheels not under test. The rear wheels of light weight vehicles must be chocked when testing the front axle. This helps prevent the front of the vehicle 'lifting' in the rollers and may improve the efficiency reading obtained before wheel lock.</p> <p>The brake performance should be assessed with the braking surfaces at <b>working temperature</b>. It is acceptable to induce heat into the braking surfaces prior to conducting the test particularly where the vehicle has been transported to the test site.</p> <p>Position the front wheels in the rollers of the brake tester and then run both sets of rollers together to align the vehicle. With one set of rollers revolving at a time, gradually depress the service brake until maximum effort is achieved, or until the wheel locks.</p> <p>Record the reading at which the maximum braking effort is achieved for each wheel and whether lock-up occurs. Release the service brake.</p> <p>Start both sets of rollers and note whether a significant brake effort is recorded from any wheel without a brake being applied. Gradually depress the service brake and watch how the braking effort for each wheel increases. From the previous tests you will know the value at which wheel slip occurs. Aim to stop just short of this. Gradually release the service brake and observe how the braking effort at each wheel reduces checking that the pedal returns to the fully off position. Stop the rollers, and record the out-of-balance braking effort between wheels on either side of the vehicle.</p> <p><b>Note 1:</b> The requirements of Standard 10 shall not apply in the case of Mass produced vehicles" if the brakes on the rear are fitted with an anti-lock device which was fitted at the time of manufacture, and it appears that the anti-lock device complies with the definition of Directive 71/320/EEC, e.g. it comprises of sensors, control valves, and/or modulators to modulate the braking force of any wheel that is about to lock.</p>	<p>8. The brake pedal must return to the fully off position.</p> <p>9. The brake effort of one wheel must not be less than 70% of the effort recorded from the other wheel on any steering axle (an axle that provides the main source of directional control of the vehicle).</p> <p>10. The braking ratio of the axles, for all values of total brake force must be less than the friction force ratio (taking into account weight transfer) between axles in running order. (See <b>Note 1</b>).</p> <p>11. The calculated service efficiency with the servo depleted must be at least 25%</p> <p>12. Where a vehicle is fitted with a full power hydraulic system, the calculated service brake efficiency after four full applications must be at least 25%. (See <b>Note 2</b>).</p> <p>13. A low braking effort must not be recorded from any wheel, indicating clearly that the parking brake is not functioning correctly.</p> <p>14. The parking brake performance must be at least 18%, (of the CLW or DGW as determined to be the highest) unless more than half of the wheels lock as operated by the park brake.</p> <p><b>Decelerometer Test (see Note 3)</b></p> <p>15. The service brake performance must be a minimum of 60%</p> <p>16. The parking brake performance must be a minimum of 18%</p> <p>17. When the service brake is applied the brake must be capable of progressive operation.</p>

## Brake Performance 09E

Method of Inspection	Required Standard
<p>Fit the brake pedal effort measuring device, and deplete the vacuum from the servo reservoir (if fitted). <b>In the case of the full power hydraulic system the pressure should not be depleted.</b></p> <p>Start both sets of rollers and, observing the load cell, progressively apply the service brake in increments. Aim to stop short of the value at which wheel-slip occurs. Record the brake effort obtained for each wheel for every increment of effort applied to the brake pedal. Stop the rollers.</p> <p><b>Where the vehicle is fitted with a servo</b> – with one set of rollers revolving at a time and with the vacuum depleted, apply a load of:</p> <ul style="list-style-type: none"> <li>• Foot control – 50kg (490N )</li> <li>• Other than foot control 40kg ( 392N )</li> </ul> <p>Record the effort obtained from each wheel. If the control reaches the end of its travel before the full effort is applied the assessment is made from the reading obtained at that point. This test applies to all service brake controls, e.g. any additional control fitted to a disabled person's vehicle that operates the system.</p> <p><b>Note 2: Where the vehicle is fitted with a full power hydraulic braking system</b> – In the case of an unmodified standard production vehicle RS 12 will be deemed to be met unless evidence suggests otherwise. For all other vehicle types; Gradually deplete the stored energy until the pressure warning device operates. Carry out four full stroke applications of the service brake. Start both sets of rollers and gradually depress the service brake until maximum effort is achieved, or until wheel lock. Record the readings for all wheels at the point which maximum effort is achieved.</p> <p><b>Parking brake</b> – If the vehicle has a parking brake which operates on the axle being tested, with one set of rollers revolving at a time, gradually operate the parking brake until maximum effort is achieved, or until the wheel locks.</p> <p>Record the reading at which the maximum braking effort is achieved for each wheel and whether lock-up occurs.</p>	<p><b>18.</b> When the service brake is applied there must not be severe grab or judder.</p> <p><b>19.</b> When the service brake is applied the vehicle should not deviate to the left or right</p> <p><b>20.</b> When the service brake is applied the pedal must return to the fully off position.</p> <p><b>21.</b> All wheels of the rear axle(s) must not lock prior to both wheels of the front axle.</p> <p><b>Transmission Parking brakes (see Note 4)</b></p> <p><b>22.</b> The transmission parking brake efficiency must be at least 18%</p> <p><b>Dynamic brake distribution assessment (see Note 5)</b></p> <p><b>23.</b> All wheels of the rear axle(s) must not lock prior to both wheels of the front axle.</p>

## Brake Performance 09E

Method of Inspection	Required Standard
<p>Drive the vehicle forward until the next axle is in the rollers. Repeat the above operations record the figures obtained and calculate the braking performance values.</p> <p><b>Note 3: Decelerometer test</b> – This method must only be used where the vehicle cannot be tested in the roller brake tester due to a design characteristic.</p> <p>Set up the decelerometer according to the manufacturer's instructions. Drive the vehicle on a level road at a steady speed of approximately 20mph and note the brake efficiency recorded when progressively applying the service brake and the parking brake separately.</p> <p>During the service brake test observe (using an assistant if necessary) whether braking is progressive, if there is grab or judder, whether the vehicle deviates to the left or right during braking, and if the pedal returns to the fully off position.</p> <p>Drive the vehicle on a level road at a steady speed of approximately 20mph and apply the service brake sufficient only to obtain wheel lock. Observe whether all the wheels of the rear axle(s) lock prior to both wheels of the front axle.</p> <p>The presenter or another person may be required to drive the vehicle under the direction of the examiner.</p> <p><b>Note 4: Transmission parking brake</b> – Place the wheels to be tested in the rollers, and run both set together to align the vehicle. Chock the other wheels of the vehicle in front of and behind each wheel. Run both sets of rollers together, and apply the brake slowly and progressively keeping the ratchet disengaged. Record and calculate readings.</p>	

## Brake Performance 09E

Method of Inspection	Required Standard
<p><b>Note 5: Dynamic brake distribution assessment</b>                      In certain instances the roller brake testing results may give the examiner justification to carry out a dynamic assessment of brake force distribution.</p> <p>Drive the vehicle on a level road at a steady speed of approximately 20mph and apply the service brake sufficient only to obtain wheel lock. Observe whether all the wheels of the rear axle(s) lock prior to both wheels of the front axle.</p> <p>The presenter or another person may be required to drive the vehicle under the direction of the examiner.</p> <p><b>Note 6:</b> The secondary system can be either one half of the split system (following failure of the other half) or secondary can be on the handbrake (Secondary/Park).</p>	

## Record of Revision

Revision	Date	Description of Change
1	27/03/2009	
2	29/06/2009	Added note 8 and required standard 23 to allow examiners to carry out dynamic assessment of brake distribution / amended RS 3 and added note 9 to include secondary/park
3	24/05/2010	Amended secondary brake performance requirement to align with RVAR 2009
4	17/06/2013	Revise notes numbering

# 10 Electromagnetic Compatibility

**Application:** All Vehicles

Method of Inspection	Required Standard
<p>The examiner will check that the vehicle complies with the required standard of interference suppression equipment.</p> <p><b>In the case of unmodified Mass Produced vehicles the standards in this section shall be considered to be met.</b></p> <p><b>Where evidence suggests that the vehicle has been modified, the examiner shall assess whether the modification would be likely to materially affect the performance of the relevant component or system, and if so, carry out assessment against the RS</b></p>	<ol style="list-style-type: none"> <li>1. The HT ignition system must be fitted with radio interference suppression equipment.</li> <li>2. The trade name or mark and trade description must be present on the interference suppression equipment</li> <li>3. There must be a maximum of 120mm separation between trade markings on suppression cables.</li> </ol>

## Record of Revision

Revision	Date	Description of Change
1	27/03/2009	



## 12 Interior Fittings

**Application:** All Vehicles

Method of Inspection	Required Standard
<p>If the vehicle is accompanied by satisfactory evidence of compliance with interior fittings and the vehicle does not appear to be modified such that it would affect the evidence, the requirements of this section may be considered to be met.</p> <p><b>RS 1 will not apply to any part of the internal surface of a mass produced vehicle, providing it is as originally manufactured and all contactable edges are at least blunted. If an item is modified, damaged or not original then it must meet the relevant requirements.</b></p> <p>In the case of a <b>Motor caravan, Ambulance, Hearse or wheelchair accessible vehicle</b> this section will only apply to the areas determined to be within the <b>head impact zone</b> for any <b>“designated seating position in the rear of the vehicle”</b>. <b>The driving and front passenger area will still be subject to the Specified Zone</b> (see <b>Notes 1 and 8</b>).</p> <p>The requirements of this section shall not apply to <b>Armoured vehicles</b> where it can be demonstrated that it is impossible to comply due to their special purpose. Where necessary it is the responsibility of the applicant to prove why it is impossible to comply.</p> <p>Items such as covers unless specifically designed for the purpose (rubber or otherwise) that are held in place by being stretched on, or attached by double sided tape or other inadequate means, rubber hosing, pipe lagging etc are not considered acceptable methods or materials. This is not an exhaustive list but provided as guidance as</p>	<ol style="list-style-type: none"> <li>1. Interior design features and fittings in the “specified zone” which are contactable with a 165mm sphere <b>in a forward direction</b> must have a radius of curvature of 2.5mm or greater, except where a projection from a panel is less than 3.2mm where the edges must be at least blunted. (see <b>Notes 3, 4 and 9</b>) see <b>Annexes 1 and 2</b></li> <li>2. Interior design features and fittings below the “specified zone” that are not adaptations for a disabled person and which are contactable with a 100mm sphere in a forward direction must be at least blunted. (see <b>Notes 3, 4 and 9</b>) see <b>Annex 2</b></li> <li>3. Switches, controls and equipment associated with those switches and controls that are designed or modified for the use of a disabled person and are contactable with a 165mm sphere must be at least blunted</li> <li>4. The edges of all gaps (i.e. grills, holes, recesses etc.) of not more than 20mm (determined by the contact points of a 165mm sphere bridging the gap) must be blunted.</li> <li>5. Control features mounted on a heating or ventilation grill element area which can be contacted by a 165mm diameter sphere must be at least blunted.</li> <li>6. All switches, control knobs etc which are mounted on the instrument panel which are within the "specified zone", contactable by a 165mm diameter. Sphere and protrude from the instrument panel by more than 9.5mm must be likely to retract or detach with no sharp edges when subject to an impact of 40kgf (see <b>Note 5</b>)</li> </ol>

## Interior Fittings 12

Method of Inspection	Required Standard
<p>to the type of item considered to be unacceptable.</p> <p>In the case of a mass produced vehicle the requirements of item 1, 3, 4, 5 and 6 shall not apply to the instrument panel forward of the driver or front passenger seating position when;</p> <ul style="list-style-type: none"> <li>• there is an air bag fitted for the forward protection of the seated occupant</li> </ul> <p><b>AND</b></p> <ul style="list-style-type: none"> <li>• the air bag was fitted at the time of manufacture.</li> </ul> <p>Where there is a driver's airbag only, the exemption will apply as in <b>Annex 1</b> to this section. Where there are airbags in front of each sitting position the exemption will apply to all of the instrument panel. Where there are twin airbags but no air bag forward of a centre front passenger position, the instrument panel criteria will apply between the vertical planes taken on the left/right outer limits of the 'head impact zone' (see <b>Note 1</b>) appropriate to that seating position.</p> <p><b>Inspection Requirements:</b> Visually check (using the measuring equipment as necessary) the vehicle interior surfaces, fittings and design features to ensure that contactable edges have an acceptable radius or have "Blunted edges" as required. <b>Note</b> the following are "<b>exempted items</b>" the surface of a window, seat controls, seat runners, seat belt locking mechanisms and the vehicle control pedals.</p> <p>The "<b>Specified zone</b>" is the area forward of a theoretical vertical plane and above a theoretical horizontal plane measured from the relevant seat in the rearmost / lowest position: see <b>Annex 2</b></p>	<ol style="list-style-type: none"> <li>7. The instrument panel lower edge within the "specified zone" must have a radius of curvature not less than 19mm or 5mm and be covered with a non-rigid material, except where an adaptation for a disabled person makes it impossible to comply. (see <b>Notes 6 and 7</b>)</li> <li>8. On a <b>seat</b> behind which there is a designated seating position, the rearward and upward facing parts of the seat frame within the head impact zone (see <b>Note 1</b>) of a seat frame must be covered with a non-rigid material, <b>and</b> have a radius of curvature of at least 5mm. (see <b>Notes 2, 6 and 8</b>).</li> <li>9. The <b>gear-lever</b> in all forward gear positions must have a radius of curvature of at least 3.2mm, on all surfaces contactable with a 165mm sphere. (see <b>Notes 3 and 10</b>)</li> <li>10. <b>Shelves</b> and other similar items fitted below the highest part of the instrument panel must have no protruding edges on their supports and that all parts facing into the vehicle have a surface at least 25mm high, and with edges rounded to a radius of curvature of not less than 3.2mm, and covered with a non-rigid material. (see <b>Note 6</b>)</li> <li>11. The inner surface of the roof structure and any attached components (e.g. grab handles, lights, sun visors) which can be contacted with a 165mm diameter sphere and any projecting part on the inner surface of the roof structure that is made from a rigid material must meet all of the following (see <b>Notes 11 and 12</b>); <ol style="list-style-type: none"> <li>a. the width is not less than the length of the projection</li> <li>b. if part of the roof structure, contactable edges have a radius of curvature of at least 5mm</li> <li>c. if an attached component, contactable edges have a radius of curvature of at least 3.2mm</li> </ol> </li> </ol>

## Interior Fittings 12

Method of Inspection	Required Standard
<p><b>Rearmost Vertical plane</b></p> <ul style="list-style-type: none"> <li>• Where the <b>rearmost designated seat is forward facing</b>; the area starts forward from a theoretical vertical plane 250mm to the rear of the front of the seat backrest (measured where the backrest meets the cushion)</li> <li>• Where the <b>rearmost designated seat is side, rear or centre facing</b>; the area starts forward from a theoretical vertical plane 250mm to the rear of the rear most part of the seat</li> </ul> <p>Where there is a fixed bulkhead or similar within the 250mm measurement this is taken to be the rearmost boundary and is subject to the requirements</p> <p><b>Horizontal Plane</b></p> <ul style="list-style-type: none"> <li>• The theoretical horizontal plane is determined to be 150mm above the top of the lowest seat cushion (measured at the lowest point) extending forward from the rearmost part of the seat back and;</li> <li>• Extending rearwards level with the top of the seat back excluding the head restraint until the horizontal plane intersects the vertical plane. See <b>Annex 2</b></li> </ul> <p><b>Exclusions from the specified zone</b> See <b>Annex 1</b></p> <p><b>Boundary of the interior/Exterior;</b></p>	<p>d. all <b>roof sticks or ribs</b> made of a rigid material (with the exception of the header rail of glazed surfaces and door frames) must not project downwards by more than 19mm.</p>

Method of Inspection	Required Standard
<p>See <b>Annex 3</b></p> <p>Where the vehicle is fitted with a detachable/fold back hood/roof, the interior shall be the area deemed to be covered by the hood/roof.</p> <p>A roll bar or similar device will be assessed to this section and the requirements of section 16 Exterior as applicable (by forming an interior surface on the underside etc) This is a subjective assessment to be made by the examiner.</p>	

**Note 1:** “**Head Impact Zone**” is the area contactable by a spherical head 165mm in diameter, the top of which is adjustable between 736mm and 840mm above the seat reference point measured with the seat in its fixed/rear-most position, and in the case of an adjustable seat, is 127mm forward of this position in either case with the seat in its lowest position.

It will be acceptable as an alternative if the applicant can show that the vehicle equipment complies with the head impact test of Directive 74/60 (or that the components are identical to those fitted to a European Approved vehicle of the same specification).

**Note 2:** Disabled Person’s vehicles, where the requirements of RS 8 shall not apply to any wheel chair.

**Note 3:** This requirement does not apply to a feature on a control provided to improve grip e.g. “knurling” provided it is blunted.

**Note 4:** In respect of items where the application of light pressure reduces the degree of projection to less than 3.2mm (e.g. speedo mileage trip button) and when depressed the height of the projection is not more than half its width, it will be sufficient for any contactable edge to be blunted.

**Note 5:** Protrusion of the component from the instrument panel is measured using equipment consisting of a 165mm diameter headform in which there is a sliding piston. Displacement of the piston is used to gauge the amount of protrusion. If **other controls** prevent the testing of a control by this method the examiner should make an assessment of the degree of protrusion likely to be measured. In cases where doubt remains the examiner may require the obstructing control to be removed to complete the assessment.

**Note 6:** A "non-rigid material" is a material which has a hardness of less than 50 shore A. For the purposes of this examination it will be deemed to be a material which is capable of depression under thumb pressure and when deformed retains a degree of protection against contact with any structure which it is covering and when released returns to its original form.

**Note 7:** The “instrument panel” should be taken to be “The area to the front of the passenger compartment, bounded by the vehicle sides and extending

## Interior Fittings 12

from the upper edge of the forward facia panel (dash panel) down to the lowest edge of the panelling (including “dash panel”, “glove box” etc).

**Note 8:** “Designated seating position” means a position where there is a seat designated for use while the vehicle is travelling on the road.

**Note 9:** The handbrake is assessed only when in the fully off position.

**Note 10:** The requirements of this item do not apply to a control / lever or a part of the control / lever when positioned within the exempt areas as defined in Annex 1 to this section.

**Note 11:** The requirements of RS 11 also apply to an opening (sun) roof including its opening and operating devices when it is in the closed position.

**Note 12:** The requirements of RS 11 DO NOT apply to parts covered with a non-rigid material or to the hood frames of convertible vehicles (this does not include catches and fasteners that are mounted on it within the specified zone).

## Annex 1 “Specified Zone Exempt Areas”

**Note:** Where the column is adjustable, the 127mm exemption zone will be checked in both the upper and lower limit positions.

The 'exempt areas' within the specified zone are

- the area having a boundary produced by the forward horizontal projection of a circle circumscribing the outer limits of the steering wheel increased by a bandwidth of 127mm, and having a lower boundary horizontal to the lower edge of the steering control (area 'A')
- the part of the instrument panel between the edge of the area specified above and the nearest inner side-wall of the vehicle having a lower boundary horizontal to the lower edge of the steering column (area 'B')
- **Area C exempts the windscreen side pillar(s) on the driver's side only. In the case of a single seater vehicle where the windscreen side pillars are in the specified exemption zone and in close proximity to the steering wheel the exemption will apply to both pillars.**

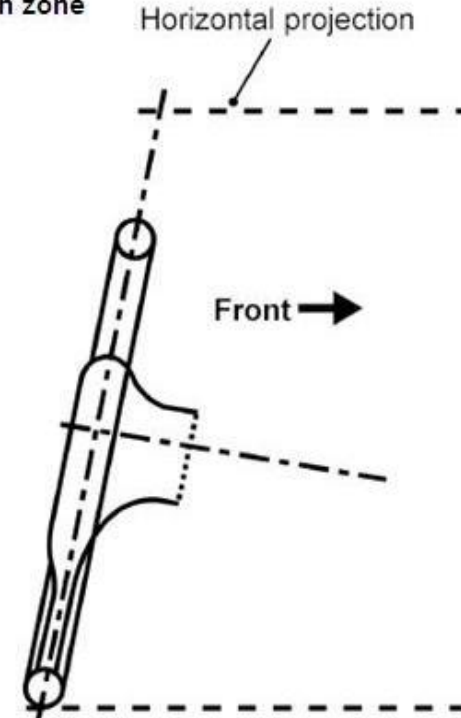
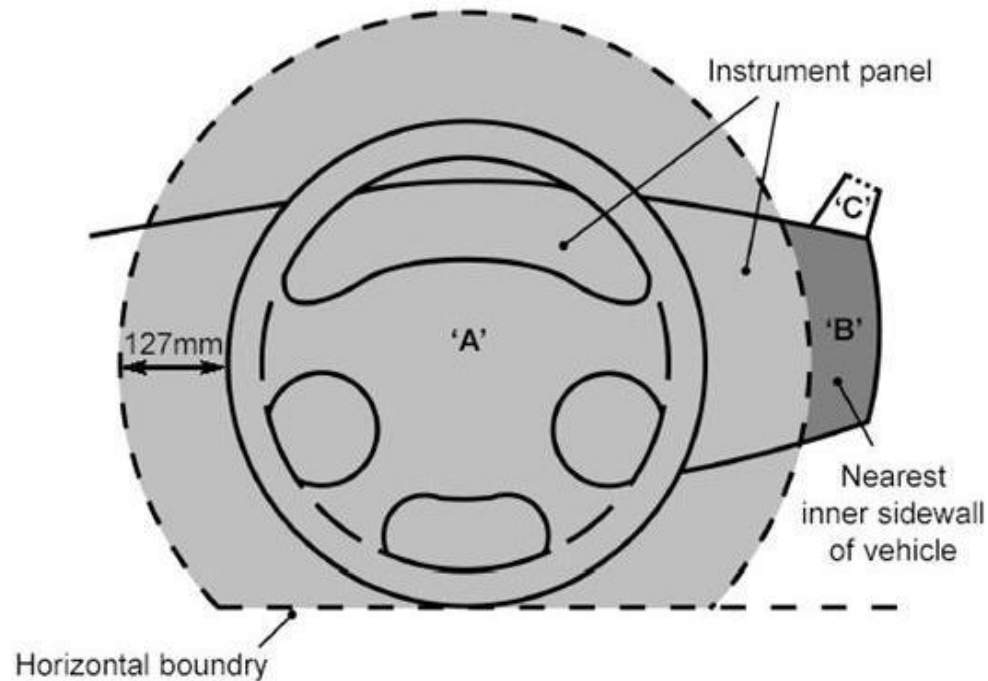

## Interior Fittings 12

## Annex 2 Specified zone and Applicable Spheres

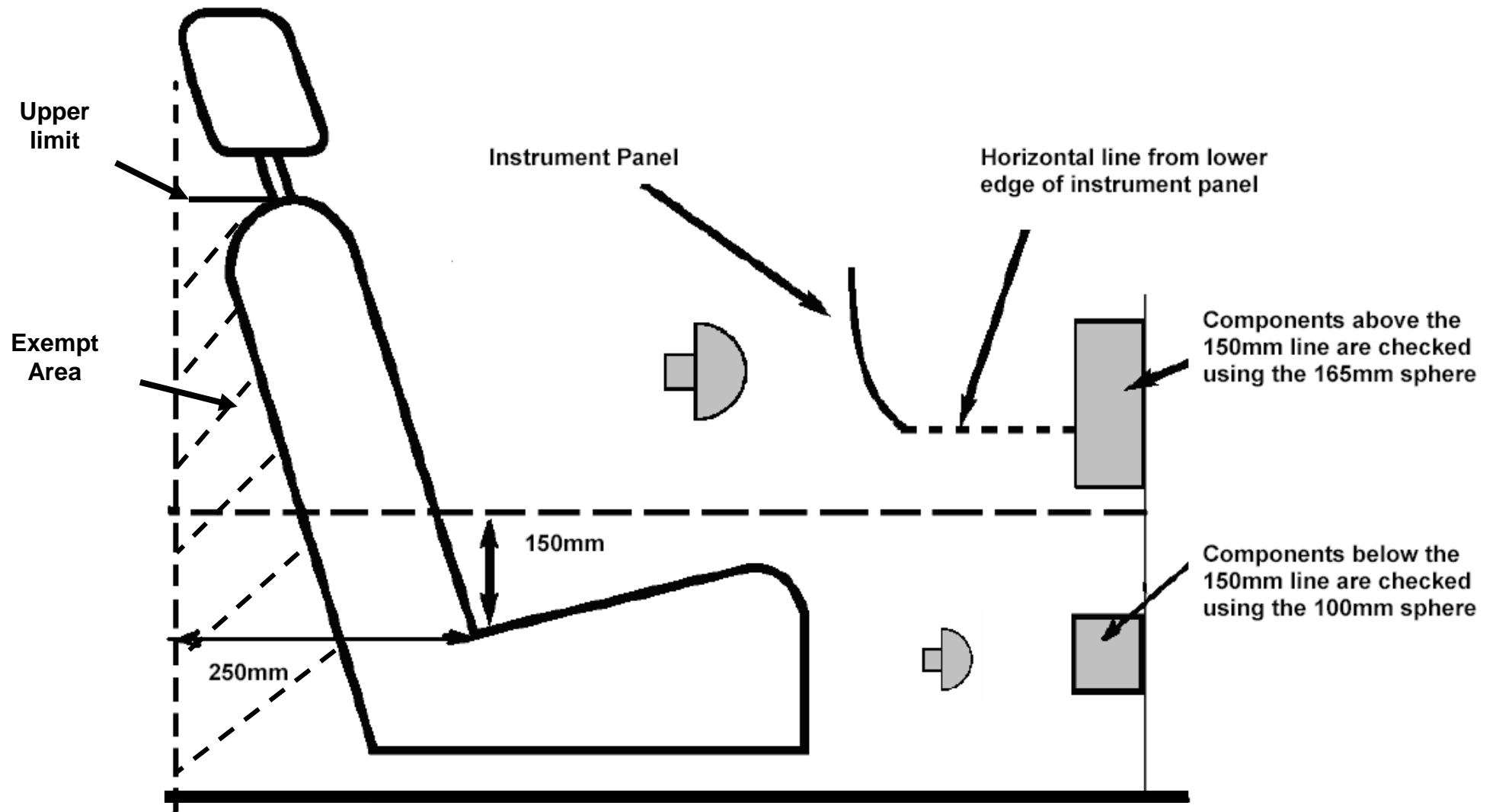

### Annex 3 Boundary of Interior Zone

Where a vehicle is not fitted with a hood/roof the interior/exterior boundary should be taken to be the midpoint between interior and exterior on for example the windscreen pillar, top edge of body side and top edge of door. Where the front of the passenger compartment abuts the front scuttle / bonnet panel and no windscreen is fitted) the interior / exterior boundary shall be 25mm towards the front from the abutment. Other areas of the vehicle are considered to be "exterior" including the area to the rear of the specified zone.

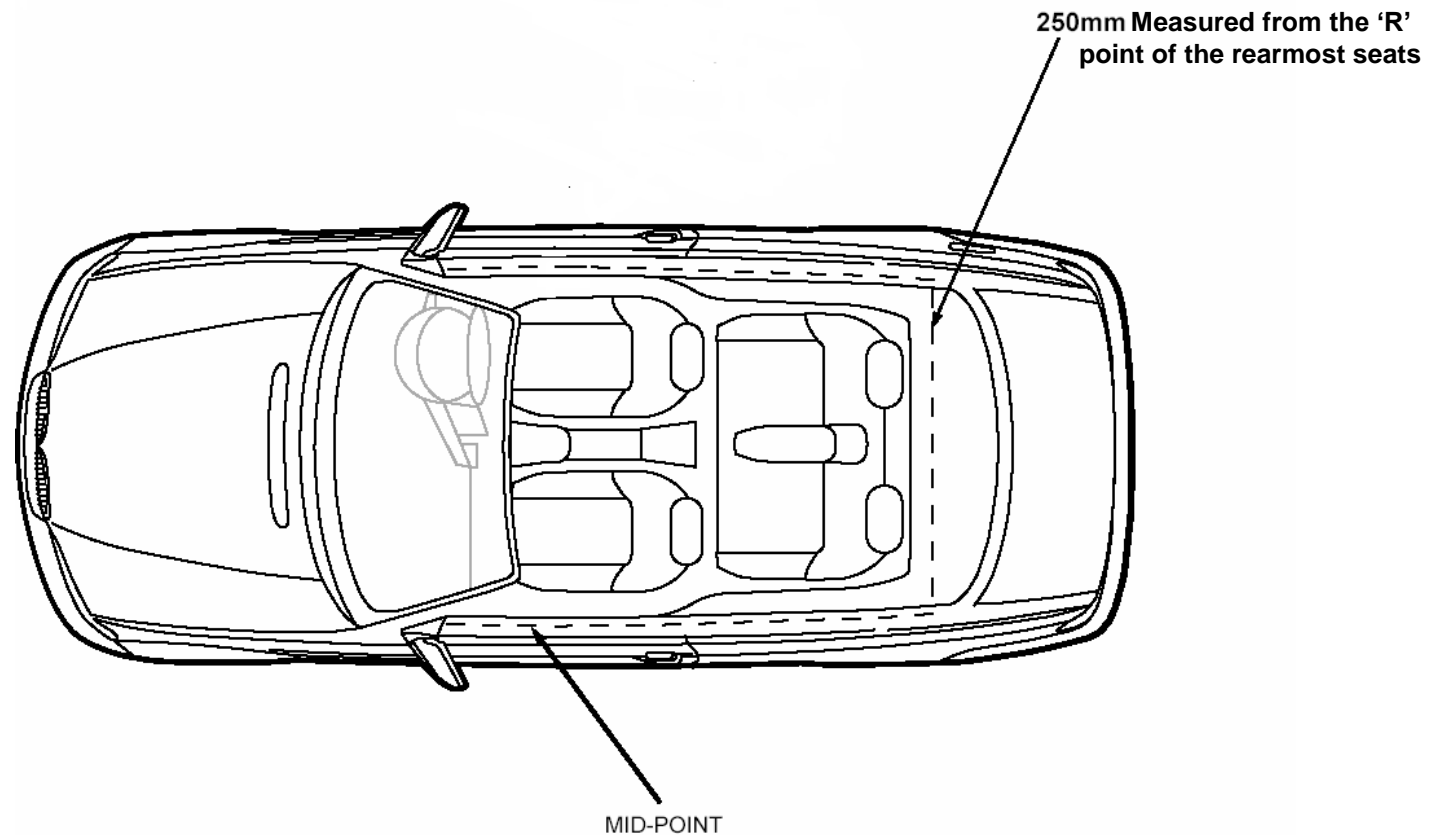



## Record of Revision

Revision	Date	Description of Change
1	27/03/2009	
2	09/04/2009	Annex 4 removed / annex 2 amended to incorporate annex 4
3	24/05/2010	Added upper limit label to annex 2 in line with TSE IVA 000M1 12 001
4	26/07/2010	RS2 amended removing 2.5mm radius requirement
5	28/02/2011	Remove reference to RS2 in 2 paragraph of MOI
6	31/10/2011	Replace the word mounted with when positioned in Note 10
7	17/06/2013	Add WAV to MoI para 3, Insert new bold text in RS1, link extra notes to RS7 & 8, Insert new text in Annexes 1 & 3
8	03/10/2016	SPV MOI expanded, Note added to Annex 1

This page intentionally left blank

## 13A Anti – Theft / Immobiliser

**Application:** Vehicles subject to Basic requirements

Method of Inspection	Required Standard
<p>Check, in addition to the normal “ignition” switch, that the vehicle is permanently fitted with an anti-theft device or an electronic immobiliser that can be activated to prevent the vehicle being driven or moved under its own power.</p> <p>A mechanical anti-theft device could be a steering lock or transmission lock. An electronic immobiliser can be activated by the ignition key (so would not be obvious) or could be separate - activated by a little fob type device</p> <p>A manually operated battery master switch or a removable steering wheel would not be considered to be an anti theft device.</p> <p>Conversions that are not based on M1 vehicles do not need to comply if there was no theft / immobiliser requirement for the base vehicle. Documentary evidence of base vehicle category or incomplete vehicle approvals will be deemed acceptable.</p> <p><b>Note 1.</b> An electronic immobiliser must be designed so as to prevent the operation of the vehicle under its own power by disabling, in the case of aftermarket fitting, at least two separate vehicle circuits that are needed for vehicle operation under its own power (e.g. starter motor, ignition, fuel supply, pneumatically released spring brakes, etc.)</p>	<ol style="list-style-type: none"> <li>1. A vehicle <b>MUST</b> be fitted with either a mechanical anti – theft device or an electronic immobiliser</li> <li>2. If fitted to the Vehicle, an anti – theft device               <ol style="list-style-type: none"> <li>a. must be operational</li> <li>b. must not operate on any part of the braking system</li> </ol> </li> <li>3. If it incorporates a mechanical part that acts upon a system used to control the vehicle               <ol style="list-style-type: none"> <li>a. It must Deactivate before the engine can be started</li> <li>b. It must be deactivated while the engine is running</li> <li>c. It must have a actuation which is a distinct and separate function from that of stopping the engine</li> </ol> </li> </ol> <p><b>Where the vehicle has no mechanical anti - theft device fitted:</b></p> <ol style="list-style-type: none"> <li>4. An electronic immobiliser must be fitted (see <b>Note 1.</b>)</li> </ol>

## Anti – Theft / Immobiliser 13A

## Record of Revision

Revision	Date	Description of Change
1	27/03/2009	
2	09/04/2009	New statement added to the heading for RS4
3	29/06/2009	Remove the requirement of documentary evidence for the immobiliser
4	24/05/2010	Amended MOI to clarify and align with RVAR 2009
5	17/06/2013	Correct typo in RS2
6	03/10/2016	New Note 1. Linked from RS 4.

## 13B Anti – Theft / Alarm

**Application:** Vehicles subject to Basic requirements (optional fitment)

Method of Inspection	Required Standard
<p>Ensure the vehicle <b>as presented</b> is accompanied by satisfactory documentary evidence of compliance with the requirements for a “Category 1 immobiliser” installation</p> <p>An <b>Armoured</b> vehicle is exempt the requirements of this section.</p> <p>A “Category 1” installation refers to an immobiliser and an alarm.</p> <p>Check that any optional Panic Alarm which does not form part of the vehicle alarm system is accompanied by satisfactory documentary evidence of compliance</p> <p>Panic Alarm means a device which enables a person to use an alarm, installed on the vehicle, to summon assistance in an emergency</p> <p>Evidence of compliance for Alarm and Panic Alarm can be one of the following:</p> <ul style="list-style-type: none"> <li>• Documentary evidence from a test laboratory</li> <li>• Documentary evidence from the vehicle manufacturer (in the case of a mass produced vehicle)</li> <li>• An original certificate of installation from a Mobile Electronics and Security Federation (MESF) accredited installer</li> <li>• An original installation report from a Thatcham Recognised Installer (TRI)</li> </ul>	<ol style="list-style-type: none"> <li>1. The vehicle <b>as presented</b> must be accompanied by evidence of compliance where an alarm is fitted</li> <li>2. The vehicle <b>as presented</b> must be accompanied by evidence of compliance where an panic alarm is fitted</li> </ol>

## Anti – Theft / Alarm 13B

## Record of Revision

Revision	Date	Description of Change
1	27/03/2009	
2	18/10/2010	Add Thatcham Recognised Installer installation report to list of acceptable evidence
3	09/05/2011	Remove VSIB from the list of acceptable evidence
4	17/06/2013	Remove the word note

# 14 Protective Steering

**Application:** Vehicles subject to Basic requirements

Method of Inspection	Required Standard
<p><b>This inspection is to assess the behaviour of the steering mechanism in the event of a frontal impact.</b></p> <p><b>Vehicles that comply with Section 53 (Frontal Impact) of this manual are exempt from this inspection providing there is no evidence to suggest the original vehicle has been modified i.e. it is still equipped with the original steering wheel etc</b></p> <p><b>Ambulance, Motor Caravan and hearse conversions that are derived from an N1 category vehicle with maximum mass greater than 1500kg and armoured vehicles are exempt from this inspection.</b></p> <p><b>Disabled person's vehicles are exempt from this section insofar as the adaptation prevents the vehicle from complying, however this does not apply where such adaptations can easily be removed, if necessary with the use of tools, in which case evidence of compliance before the vehicle was adapted is required.</b></p> <p>Examine the steering control for sharp points or edges.</p> <p>Check for parts of the steering control likely to catch in clothing.</p> <p>Examine the steering wheel and column assembly for evidence of energy absorbing properties. The steering control, the steering column, the steering shaft, the steering gear housing and all other components designed to contribute to the absorption of energy in the event of impact against the steering control may be considered.</p>	<ol style="list-style-type: none"> <li>1. Any part of the steering control directed towards the driver which is contactable with a sphere of 165mm diameter must have a radius of curvature of at least 2.5mm. This does not apply if the vehicle is a <b>mass-produced vehicle</b> and has an airbag fitted to the steering control which was fitted at the time of manufacture. However in this case all parts of the steering control must be blunted.</li> <li>2. The steering control must be designed, constructed and fitted in such a way that it is not possible to catch the driver's clothing or jewellery during normal driving movements.</li> <li>3. The steering control and column assembly must provide adequate protection to the driver by absorbing energy from a driver-steering wheel impact. This is the case if the steering control has an approval (evidence may be markings or documents), or is similar to an approved steering control. The vehicle should be assessed using the material in <b>Annex 1</b>.</li> <li>4. The vehicle and steering column assembly must be designed such that in the event of a frontal impact at 48km/h (30mph) the rearward horizontal displacement and vertical displacement of the top of the steering column and its shaft do not exceed 127mm. The vehicle should be assessed using the material in <b>Annex 1</b>.</li> <li>5. Airbags are not permitted on vehicles which are not <b>mass-produced</b>.</li> </ol>

## Protective Steering 14

Method of Inspection	Required Standard
In order to assess the system for RS 3 and RS 4, the inspector will need access to all steering components, mountings and vehicle structure forward of any steering components. This may involve the removal of body and trim panels.	

## Annex 1

### The vehicle structure ahead of the steering rack or box

Of primary concern is the position of the steering rack or box. If the rack or box is ahead of the axle centreline, there will clearly be less of the vehicle structure available to deform and absorb energy than if the rack is behind the axle. Check for some energy absorbing device such as

1. an energy absorbing bumper, or bumper mounting (e.g. mounted on hydraulic dampers or telescopic tubes);
2. a crushable section of chassis comprising one or more deliberate weaknesses;
3. in the case of a tubular chassis, a deliberately un-triangulated bay or arrangement of tubes likely to deform progressively;
4. in the case of a composite monocoque an area of bodywork which the presenter can demonstrate has been designed to crush progressively and dissipate energy;
5. in the case of any vehicle, a non-structural nose cone of any material which the presenter can demonstrate has been designed to absorb energy.

**Note 1:** The first area of the vehicle to make contact with a barrier in a crash test may not be the chassis. The front wheels may do this. If this is the case, the load path from the hub carrier to its mountings on the chassis should be examined. The initial deformation might take place to the sides rather than the front of the chassis.

**Note 2:** If the steering rack or box is mounted behind the axle centreline, then there is far more room for the chassis to deform before moving the steering column backwards. **A well designed vehicle will minimise further deformation once the impact has reached the steering rack or box.**

**Note 3:** In cases where the steering rack or box is mounted behind the axle centreline, it may well be behind part of the engine or gearbox. In this case, check that no rigid part of the power plant is likely to bear directly against the end of the steering shaft as it enters the rack or box and in so doing, transmit a force up the column towards the driver.

### An offset between the steering column and the input shaft of the steering rack or box

In cases where an intermediate shaft is used, it will be connected to the steering column at one end and the steering rack or box at the other, by means of universal joints and/or flexible couplings. The greater the angle through which the joints run, the more effective they will be in preventing movement being transmitted up the steering column. While it is unlikely that joints of this type will work at angles above 30 degrees, they are unlikely to be effective if the angle between the steering column and the intermediate shaft (when viewed from the side or the top of the vehicle) is less than 10 degrees.

## Protective Steering 14



### **A telescopic intermediate shaft**

This is a common arrangement and may take the form for example of a sliding splined shaft, a sliding clamp arrangement on a non circular shaft (e.g. triangular), or a device that permits disengagement of the upper column from the lower column.

### **A collapsible element in the upper column**

This may take many forms. Expanded metal tubes or convoluted tubes (in association with sheer pins in the column shaft) or sliding splines are three of the most common. These are designed primarily to allow the steering wheel and column to move away from the driver while absorbing some of his or her deceleration if the driver were to hit the steering wheel.

**Note:** Driver impact against the wheel is still possible even when wearing a seat belt, particularly a fixed type rather than an inertia reel type.

### **A steering wheel incorporating an airbag**

In cases where the vehicle was designed and fitted with an air bag as manufacturer's original equipment, there should be no reason to doubt its effectiveness providing the vehicle has not subsequently been modified.

### **Steering wheel construction**

It is vital that the wheel is constructed so as to minimise the risk of facial injuries or concussion. The rim of the wheel should be padded or at least made from a material which when deformed does not splinter or fragment. The centre boss should be padded or recessed below the level of the rim. Wheels with a very deep dish are stiffer than flatter wheels and, as such will absorb less energy.

The centre boss will often be of a collapsible type comprising a convoluted crushable section or a series of metal fingers with a deliberate fold introduced to initiate a collapse.

Bolts used to secure the wheel to its boss (if exposed) should ideally be flush with the wheel surface but otherwise are required to meet the radius requirements if contactable.

Bare metal spokes are allowed as long as they conform to the edge radius requirements. Components likely to catch in the driver's clothing or jewellery are not permitted.

**Note:** It is possible to fit an 'aftermarket' steering wheel which has been approved for use on any design of column. These will be referred to as "Separate Technical Units". If the presenter can provide satisfactory documentary evidence that this is the case, a "Separate Technical Unit" may be acceptable.

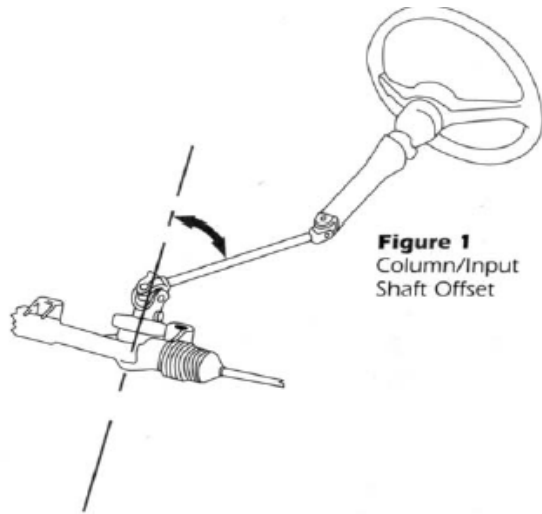

**Figure 1**  
Column/Input  
Shaft Offset

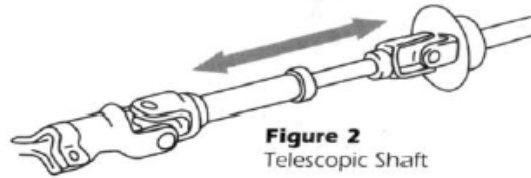

**Figure 2**  
Telescopic Shaft



**Figure 3**  
Sliding Clamp

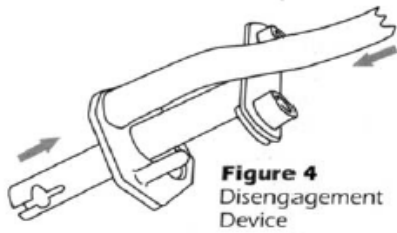

**Figure 4**  
Disengagement  
Device

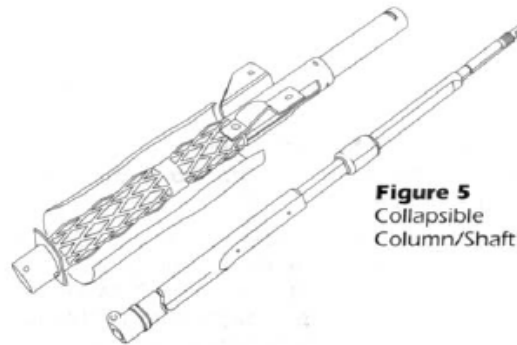

**Figure 5**  
Collapsible  
Column/Shaft

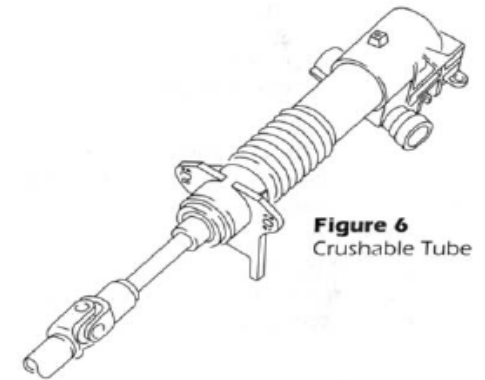

**Figure 6**  
Crushable Tube

## Record of Revision

Revision	Date	Description of Change
1	27/03/2009	
2	24/05/2010	Amended MOI relating to Motor Caravan, Ambulance, Hearse and Armoured Vehicle to align with RVAR 2009, add exemption for disabled persons vehicle to align with RVAR 2009

This page intentionally left blank

# 15 Seat Strength

**Application:** All Vehicles

Method of Inspection	Required Standard
<p>In the case of a <b>Motor-caravan, Ambulance, Hearse:</b></p> <p>(a) The required standards do not apply to seats intended for use solely while the vehicle is stationary or for when the vehicle is not used on a public road. (which only have to be secure enough to retain the seat in its intended position) and</p> <p>(b) Any seats which are not for use when travelling on a public road must be clearly identified to users by means of a pictogram or a sign with appropriate text.</p> <p>(c) base or incomplete vehicle approvals will be deemed acceptable provided the maximum mass of the original approvals has not been exceeded</p> <p>(d) Seats designed for dual function as sleeper beds should be assessed in the seating mode only.</p> <p>Seats designed for a disabled person only need to comply with required standard 1.</p> <p>In the case of a <b>wheelchair accessible vehicle:</b></p> <p>(a) a wheelchair location is considered a seating position but the wheelchair is exempt from this section,</p> <p>(b) for each wheelchair sufficient space must be provided, and when the vehicle is in motion must face forward or rearward.</p> <p><b>Note 1:</b> If attached to a non-metallic floor pan separate from the chassis, adequate support to spread the load of the anchorage is required, e.g. spreader plates/stiffening ribs etc.</p>	<ol style="list-style-type: none"> <li>1. Every seat must be securely attached to the vehicle structure, or other obvious suitable load bearing parts of the vehicle (see <b>Notes 1, 2 and 3</b>).</li> <li>2. Every seat mounting must be of adequate strength to support the loads likely to be imposed (see <b>Notes 1, 2 and 3</b>).</li> <li>3. Each seat, seat back adjustment and seat displacement system must incorporate an automatic locking system which operates in all positions provided for normal use.</li> <li>4. A seat fitted with a displacement device to facilitate access by passengers must be fitted with an unlocking control which is accessible from outside the vehicle when the door is open. Where the seat immediately behind the seat concerned is designated for an adult, the unlocking control must also be easily accessible from this position.</li> <li>5. The rear parts of the seats must not have rough or sharp edges likely to increase the risk of injury to the occupants. See <b>Note 6</b></li> <li>6. A system of head restraint must be fitted on every outboard front seat.</li> <li>7. For outboard front seats the height of the top of the head restraint above the R point must be at least 700mm, (<b>see Annex 1</b>) taking into account <b>Note 4</b>.</li> </ol>

## Seat Strength 15

Method of Inspection	Required Standard
<p><b>Note 2:</b> In respect of a seat that comprises of a “lift-out” backrest and/or squab it will be considered secure providing, when in the operational position, it is located such that there is no possibility of accidental lateral or longitudinal movement within the vehicle whether it is in use or not.</p> <p><b>Note 3:</b> On a seat to which a seat belt is mounted (integral seat belt) consideration must be given to the seat mounting as part of the seat belt anchorage.</p> <p>A seat/seat back INERTIA locking device is acceptable, i.e. a device that operates during the deceleration the vehicle.</p> <p><b>Note 4: Unmodified mass produced vehicles are deemed to comply with required standard 7 and 8.</b> Height adjustable head restraints must achieve this dimension at the lowest positions to which adjustment is possible. There should not be any in-use position resulting in a height of less than 700mm. <b>see Annex 1</b></p> <p><b>Note 5:</b> The function of a head restraint is to limit the rearward displacement of an adult occupant’s head in relation to their torso in order to reduce the danger of injury to the cervical vertebrae of that occupant in the event of an accident. Head restraints can either form part of the seat itself, or be detachable and adjustable for height.</p> <p><b>Note 6:</b> The surface of the rear parts of seats shall exhibit no dangerous roughness or sharp edges likely to increase the risk of severity of injury to the occupants. This requirement is considered as satisfied if the vehicle complies to section 12</p> <p><b>Note 7:</b> Where the seat is either part of the structure or is fixed to the structure with no adjustment then the head restraint may be attached to the vehicle structure or roll bars</p>	<ol style="list-style-type: none"> <li>8. Where optional headrests are fitted to seats other than outboard front seats, the height of the top of the head restraint above the R point must be at least 700mm (<b>see Annex 1</b>) taking into account <b>Note 4</b>.</li> <li>9. The head restraint must be at least 85 mm wide each side of the vertical centre line of the seat and at least 100mm high.</li> <li>10. The head restraint must be securely attached to the seat. (see <b>Note 7</b>)</li> <li>11. The head restraint must be appropriately positioned and of adequate strength to fulfil its function. (see <b>Note 5</b>)</li> <li>12. There must be a gap of no more than 25mm between the top of the seat the bottom of the head restraint in its lowest in-use position for adjustable head restraints and 50mm for fixed type head restraints.</li> <li>13. The head restraint must not have any roughness or sharp edges likely increase the risk of injury to the occupants.</li> <li>14. The surface of the head restraint contactable with a 165mm sphere travelling horizontally in a rearward direction must either be rigid and have a radius of curvature of no less than 5 mm or be covered with padding to the extent that a degree of protection is provided from any internal hard parts of the head restraint</li> </ol>

## Annex 1

Seat reference point is measured with the seat in its rearmost and lowest position as well as:

- a. In the case of a seat with an adjustable back rest, the measurements should be made with the seat back rest adjusted to an angle of 25°, with the assessment tool being parallel to the centre line of the seat back rest
- b. In the case of a seat with a fixed back rest, the assessment tool being parallel to the centre line of the seat back rest up to a maximum of 25° (irrespective if the fixed seat back is inclined more than 25°).

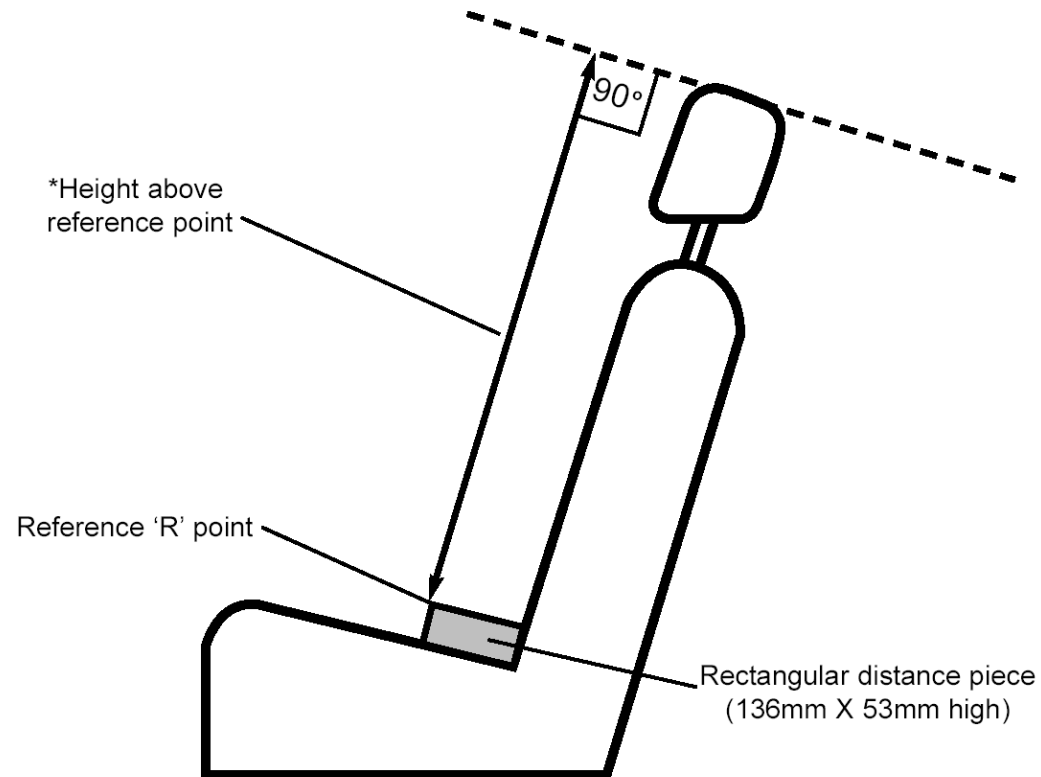

## Record of Revision

Revision	Date	Description of Change
1	27/03/2009	
2	24/05/2010	Note 5 amended following feedback from examiners and agreement from VCA and TTS after taking into account practicality of altering vehicles. RS6 amended to include position of head restraint to ensure that position of head restraint does not impinge on its function, as detailed in note 6. Amended MOI wording to clarify base approval acceptance and align with RVAR 2009
3	31/07/2011	Changed <b>Note 5</b> to read unmodified mass produced vehicles and correction to typo in <b>Note 6</b>
4	17/06/2013	Insert new sub paragraph (d) and remove numbering from note 4



# 16 Exterior Projections

**Application:** All Vehicles

Method of Inspection	Required Standard
<p>Exterior projections will be assessed between the 'floor line' and a height of 2 metres from the ground and includes damaged, modified or repaired bodywork.</p> <p>See <b>Annex 1</b> for determination of floor line.</p> <p><b>In the case of unmodified Mass Produced M1 vehicles</b> the standards in this section shall be considered to be met.</p> <p><b>In the case of unmodified mass produced vehicles in categories other than M1</b> the vehicle must meet the full requirements of this section.</p> <p><b>Where evidence suggests that the vehicle has been modified</b>, the examiner shall assess whether the modification would be likely to materially affect the performance of the relevant component or system, and if so, carry out assessment against the RS</p> <p>Sliding windows are to be assessed in the closed position.</p> <p>The cab area of <b>Motor ambulances, motor caravans, and hearses</b> must comply fully with the standards. Other areas of the vehicle are exempt from the standards if the applicant can prove its special purpose makes it impossible to fully comply. The cab is the part of the bodywork which constitutes the driver and passenger compartment including the doors.</p> <p>An <b>Armoured</b> vehicle shall be exempted from any requirement of this section if it can be demonstrated to the satisfaction of the Approval Authority that it is impossible for the vehicle to comply due to its special purpose.</p>	<ol style="list-style-type: none"> <li>1. A mascot, emblem or other ornamental object must retract or detach when a reasonable force is applied, <b>and</b> leave a base or mounting free from sharp edges that does not protrude from the surface by more than 10mm.</li> <li>2. All 'hard' parts contactable with a 100mm sphere, which form an external surface or protrude 5mm or more from the external surface must have a radius of curvature of at least 2.5mm (see <b>Notes 2 and 3</b>).</li> </ol> <p><b>The criteria of Standard 2 DOES NOT apply to the following, which must be checked to their individual requirements:</b></p> <ol style="list-style-type: none"> <li>3. Protrusions less than 5mm contactable with a 100mm sphere must have blunted edges.</li> <li>4. Wheel arches must be 'turned inwards', or have a radius of curvature of at least 2.5mm</li> <li>5. Grills, gaps, slots, grooves, channels, recesses and holes that have a width of 10mm or less as determined by the contact points of a 100mm sphere must be blunted.</li> <li>6. Grills, gaps, slots, grooves, channels, recesses and holes which have a width of more than 10mm and up to 25mm determined by the contact points of a 100mm sphere must have a radius of curvature of at least 0.5mm.</li> </ol>

## Exterior Projections 16

Method of Inspection	Required Standard
<p>The assessment will not apply to exterior mirrors or to the ball of towing devices, a Frontal protection system will be deemed to have met the requirements if it is unmodified and complies with Section 60 and in all circumstances has no contactable edges that have a radius of less than 2.5mm.</p> <p><b>Note</b> the floor line itself is subject to the requirements of RS2 i.e. the 2.5mm radius requirement applies.</p> <p><b>Boundary of the interior/Exterior;</b> See <b>Annex 2</b></p> <p>Where the vehicle is fitted with a detachable/fold back hood/roof, the interior shall be the area deemed to be covered by the hood/roof in the closed/fitted mode. Any parts of the hood/roof are subject to RS2 and RS3 if in the folded mode if they project beyond the area covered by the hood/roof when it is in the closed mode.</p> <p>A roll bar or similar device will be assessed to this section and the requirements of section 16 Exterior as applicable (by forming an interior surface on the underside etc) This is a subjective assessment to be made by the examiner.</p> <p>Where a vehicle is not fitted with a roof the areas referred to in Section 12 Annex 1 shall be assessed to the requirements of this section. The exempted areas detailed in Annex 1 of Section 12 still apply to roofless vehicles if a windscreen is fitted.</p> <p>Where a vehicle consists of a frame structure or the surface has holes or sections without body panels fitted, all parts that are accessible with a 100mm sphere from the exterior of the vehicle are assessed against the criteria of this section, however where such items are deemed to be located within the interior of the vehicle, this section will only apply where they are located no more than 200mm from the outermost external surface surrounding the hole/gap and they are not an exempt item as listed in the Inspection Requirements of Section 12.</p>	<ol style="list-style-type: none"> <li>7. Grills, gaps, slots, grooves, channels, recesses and holes which have a width of more than 25mm and up to 40mm determined by the contact points of a 100mm sphere must have a radius of curvature of at least 1mm.</li> <li>8. Grills, gaps, slots, grooves, channels, recesses and holes which have a width of more than 40mm determined by the contact points of a 100mm sphere must have a radius of curvature of at least 2.5mm</li> <li>9. Where contactable with the 100mm sphere sheet metal edges must be folded back on themselves (180 degrees)</li> <li>10. Where contactable with the 100mm sphere a glass/fibre reinforced plastic panel edge must have a radius of curvature of at least 1.5mm.</li> <li>11. Wiper blades and their supports fitted to the windscreen, headlamps and to the rear window must be at least blunted.</li> <li>12. Any protrusion of a wheel, wheel nut, hub cap, or wheel disc from the wheel rim must be at least blunted.</li> <li>13. Wheels must not be fitted with wing nuts.</li> <li>14. Any wheel disc or central wheel securing nut that project beyond the body plan form must have a radius of curvature of at least 30mm, <b>and</b> cannot project from the plan form by more than 30mm.</li> <li>15. Rain/air deflectors mounted around windows on the sides of the vehicle must have a radius of curvature of at least 1mm on any edge capable of being directed outwards.</li> <li>16. Aerial shafts must be blunted and fitted with a 'fixed end capping' with a radius of curvature of at least 2.5mm.</li> </ol>

## Exterior Projections 16

Method of Inspection	Required Standard
<p>Contactable parts of exposed suspension and steering components must comply with radius requirements. However areas to be assessed shall be in accordance with <b>Figure 5 Annex 1</b>.</p> <p>The area within wheels and tyres is not considered to be an external surface. (Spare wheels must still be assessed when they are externally mounted.)</p> <p>Mesh is only considered to provide an external surface if it is made of a rigid material and is of a type utilised in the automotive industry, mesh that is typically used in the construction industry is not acceptable i.e. chicken fencing.</p> <p>A dummy registration plate will be used in order to assess the contactable parts of any number plate brackets fitted.</p> <p>A 'hard' feature is a feature which has a hardness of at least 60 Shore A (as a guide, deemed to be harder than the average pencil eraser). The measurement of a protrusion is taken from the "external surface". The external surface is the first surface that the 100mm sphere can contact nearest to the protrusion in question. Where the sphere does not touch a surface (possibly due to the length of the projection) or contacts a further projection, a simple measurement from the projections mounting surface will be made.</p> <p>Items such as covers unless specifically designed for the purpose (rubber or otherwise) that are held in place by being stretched on, or attached by double sided tape or other inadequate means, rubber hosing, pipe lagging etc are not considered acceptable methods or materials. This not an exhaustive list but provided as guidance as to the type of item considered to be unacceptable.</p> <p><b>Note 1:</b> A frontal protection system means a separate structure or structures such as a bull bar or a supplementary bumper, which is</p>	<p><b>17.</b> Flexible plastic or rubber parts must at least have a blunted edge.</p> <p><b>The following Standards must be met IN ADDITION to Standard 2:</b></p> <p><b>18.</b> The ends of any bumper fitted to the vehicle must be turned inwards, or integrated within the bodywork. (See <b>Note 5</b>)</p> <p><b>19.</b> Handles, hinges, push buttons, and fuel tank filler caps must not protrude more than 50mm from the external surface if the component does not project beyond the extreme outer edge of the vehicle. This is reduced to 40mm in all other cases.</p> <p><b>20.</b> All handles must be enclosed in a protective surround or be recessed, unless they cannot in any circumstance project beyond the extreme outer edge of the vehicle.</p> <p><b>21.</b> Handles that rotate parallel to the plane of the panel must be turned inwards towards the plane of the panel.</p> <p><b>22.</b> The open end of any handle that rotates parallel to the plane of the panel <b>and</b> protrudes beyond the extreme outer edge of the vehicle must face rearwards.</p> <p><b>23.</b> Any handle that does not protrude beyond the extreme outer edge of the vehicle must have:</p> <ul style="list-style-type: none"> <li><b>a.</b> The open end facing rearwards, or</li> <li><b>b.</b> the open end shielded to the front by a protective surround, or</li> <li><b>c.</b> the open end recessed into the bodywork, or</li> <li><b>d.</b> a gap measuring a maximum of 2mm between the open end of the handle and the vehicle body.</li> </ul> <p><b>24.</b> Handles that pivot outwards must have the open end facing rearwards or downwards, unless they have an independent return mechanism which in event of return mechanism failure will not allow the handle to project more than 15mm.</p>

## Exterior Projections 16

Method of Inspection	Required Standard
<p>intended to protect the external surface of the vehicle above and below the original equipment bumper from damage in the event of a collision with an object. Structures with a maximum mass of less than 0.5kg intended to protect the lights are excluded from this definition.</p> <p><b>Note 2:</b> RS 2 will not apply to any part of the external surface of a mass produced vehicle, if as originally manufactured by the vehicle manufacturer, providing all contactable edges are at least blunted. If an item is modified then it must meet the radius requirements.</p> <p><b>Note 3:</b> Hood or tonneau cover press studs fitted to a convertible vehicle must at least be blunted</p> <p><b>Note 4:</b> Where a window has been modified to meet this standard, it will only be acceptable if it is either fully bonded to the vehicle or has been rendered inoperative or restricted in its travel by a method as used by a manufacturer on an approved vehicle.</p> <p><b>Note 5:</b> All bumpers must have all ends “turned in or integrated with the body work” this criteria is not achievable by the material itself the requirement is considered to have been met if the following is achieved:</p> <p>A bumper made from tubular material must turn backwards into the body/chassis or have an end cap fitted that either gives the same effect (not simply close the end of the tube) or provide a dome shape equal in radius to the section of the tube or the tube can form a continuous loop (i.e. be endless such as is the case with a Bull bar or light guard)</p> <p>A bumper made from a flat material would require an end that turns to the body/chassis or completely back on itself forming a loop.</p> <p>In all cases other than where the dome or loop criteria is achieved all ends of the bumper must be within approximately 30mm of the body work/chassis or tyre.</p>	<p><b>25.</b> Windows that open outwards from the external surface of the vehicle (other than fitted to an ambulance in the medical area to the rear of the driving seat, or the living area of a motor caravan) must not have exposed forward facing edges.</p> <p><b>26.</b> Windows that open outwards from the external surface of the vehicle (other than fitted to an ambulance in the medical area to the rear of the driving seat, or the living area of a motor caravan) must not protrude beyond the extreme outer edge of the vehicle. (see <b>Note 4</b>)</p> <p><b>27.</b> Headlight visors and rims must not project more than 30mm beyond the lens surface (measured horizontally from the point of contact of a 100mm sphere touching lens and visor/rim).</p> <p><b>28.</b> A jacking bracket must not project beyond the floor line lying directly above it by more than 10mm.</p> <p><b>29.</b> An exhaust tailpipe must not project beyond the floor line lying directly above it by more than 10mm, unless it terminates in a radius of curvature of at least 2.5mm and in all cases project no more than 150mm. In the case of side mounted exhausts the tailpipe must terminate no more than 50mm from the extreme outer edge of the vehicle.</p>

## Exterior Projections 16

## Annex 1

The theoretical floor line is determined by the series of contact points formed between the vehicle and the application of a curved area of a cone segment. The curved area is at an angle of 30 degrees from the vertical. The points of contact are used as a guide to judge the actual floor line. I.e. Certain items that the cone contacts are likely to move or offer little resistance prior to detaching and are therefore excluded from the actual floor line. In addition where the cone contacts 2 or more points and cannot contact other items that may determine the floor line a judgement will be made as to where the cone would contact the other items. Jacking points, exhaust pipes (**only** where the tail pipe protrudes from under the body – side mounted exhausts may actually provide the points of contact that form the floor line) and wheels are not taken into consideration when the floor line is being determined.

Wheel arches are assumed to be filled in (in the case of clam shell wings etc the dispensation shall only apply to an area as judged to have been covered by a standard cycle wing) – exempting any projection inboard of the turned in edge of the wheel arch.

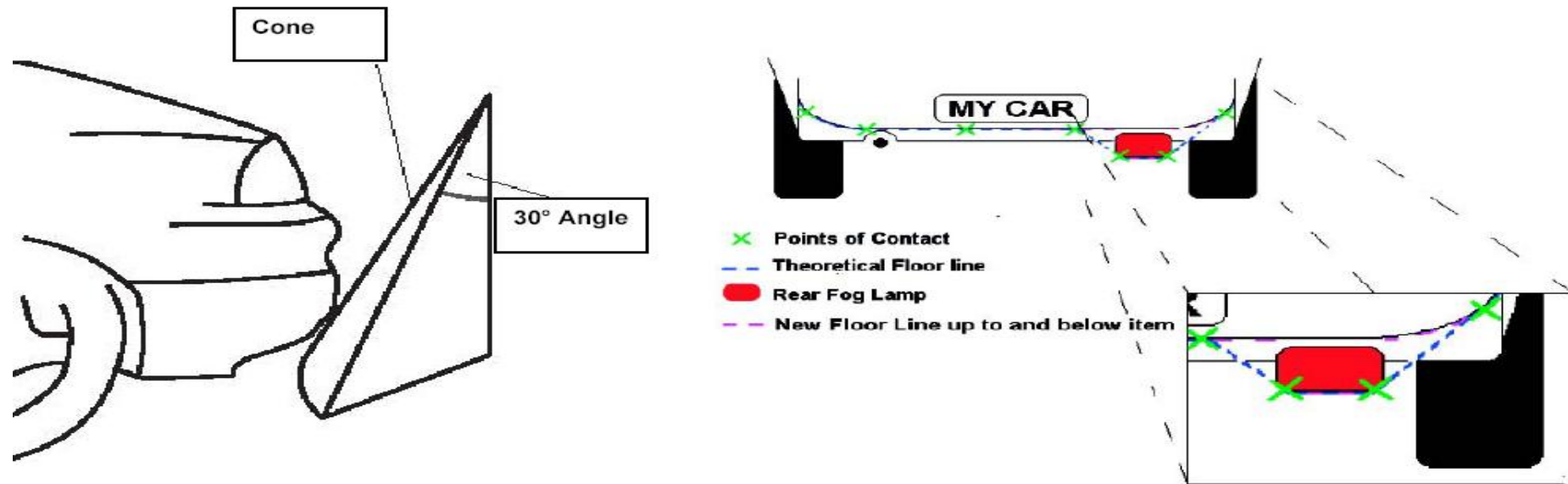

## Exterior Projections 16

Figure 1

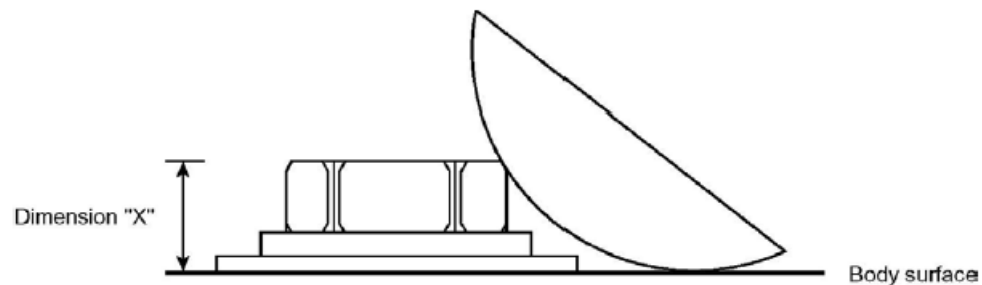

If dimension "X" is 5mm or greater, contactable edge requires a 2.5mm radius

If dimension "X" is less than 5mm | contactable edge requires to be blunted

Figure 2

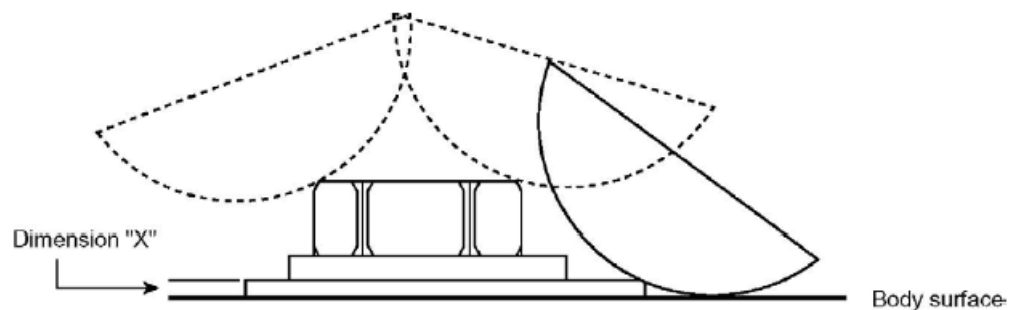

If dimension "X" is 5mm or greater, contactable edge requires a 2.5mm radius

If dimension "X" is less than 5mm | contactable edge requires to be blunted

**Note:** In this example the measurements of the projections are all taken from the "Body surface" as no other "external surface" is provided by the components. (see Fig. 3)

## Exterior Projections 16

Figure 3

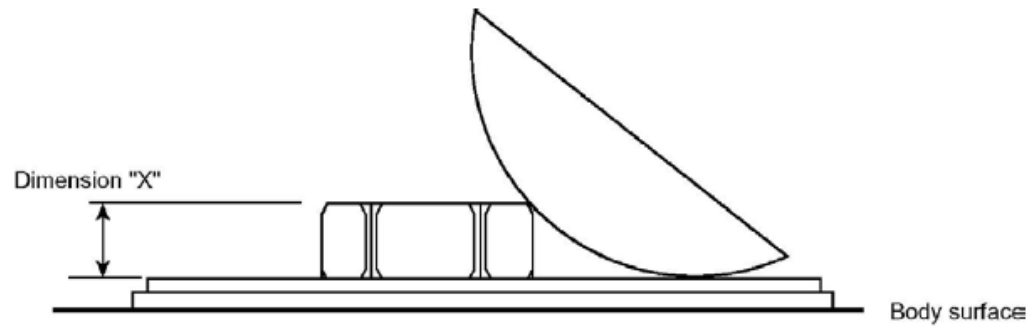

If dimension "X" is 5mm or greater, contactable edge requires a 2.5mm radius

If dimension "X" is less than 5mm ( ) contactable edge requires to be blunted

**Note:** In this example the measurement of the projection of the bolt is taken from the surface of the plate/plinth which itself creates an "external surface". The measurement of the projections of the plate/plinth being taken from the "body surface". (see Fig. 2)

Figure 4

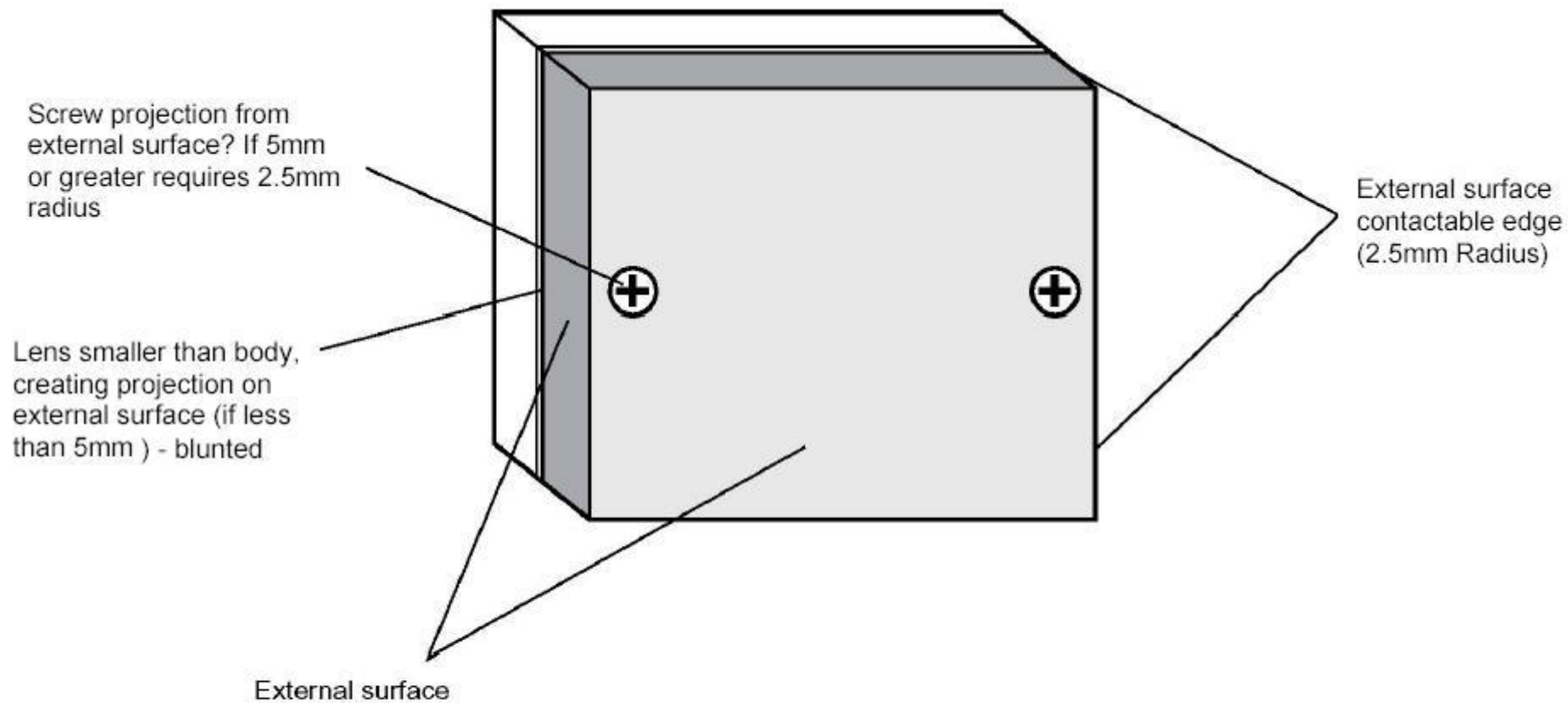

## Exterior Projections 16



Figure 5

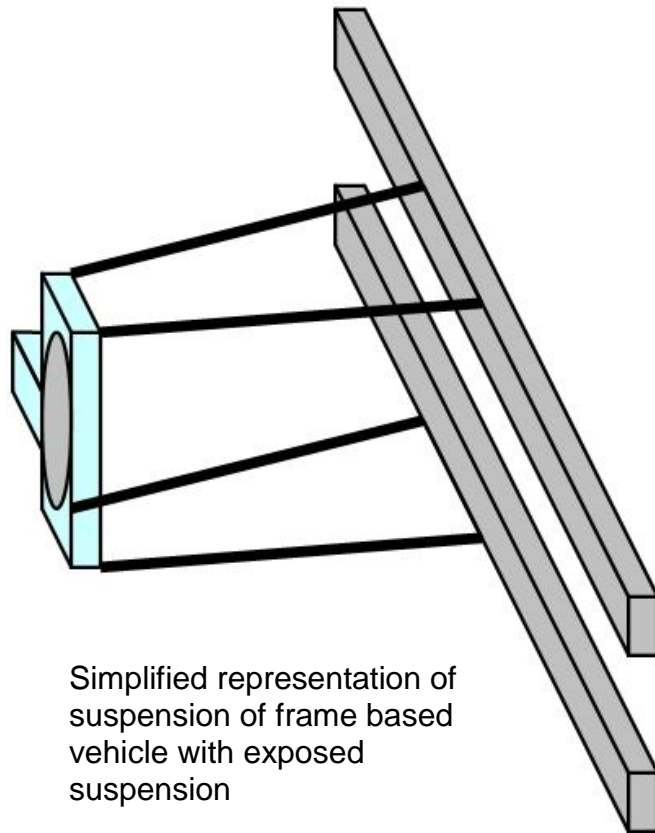

Simplified representation of suspension of frame based vehicle with exposed suspension

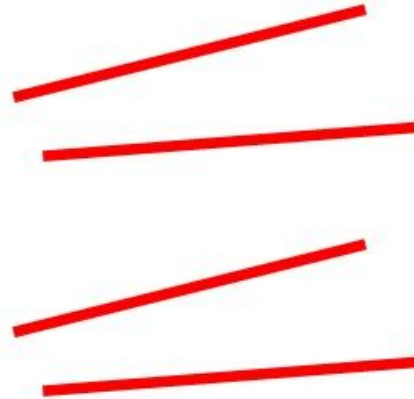

Contactable exterior surfaces of functional steering and suspension components are assessed against relevant radius requirements.

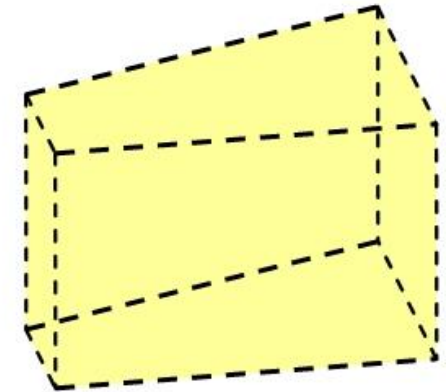

Items within the volume enclosed by suspension components are exempt from exterior projection assessment.

## Annex 2: Interior/Exterior Assessment

Where the vehicle has a detachable (or fold back) hood/roof, the interior shall be taken to be the area covered by the hood/roof.

Where a vehicle is not fitted with a facility to attach a hood/roof the interior/exterior boundary should be taken to be the mid point between interior and exterior on for example the windscreen pillar, top edge of body side and top edge of door.

Where the front of the passenger compartment abuts the front scuttle / bonnet panel and no windscreen is fitted then the interior / exterior boundary shall be 25 mm towards the front of the passenger compartment, a windscreen will otherwise form the boundary

All areas of the vehicle to the rear of the specified zone are considered to be "exterior"

Where the area behind the rear bulkhead of the passenger area and the rear of the vehicle is covered by a 'soft' cover held in place by pop studs, (e.g. a Lotus seven type vehicle), the cover is considered an access lid. In these cases the exterior projections should be assessed with the cover in place. The area beneath the 'access lid' is deemed to be the interior of the vehicle and if it appears to be behind a permanent bulkhead it is exempt of any interior fitting requirements.

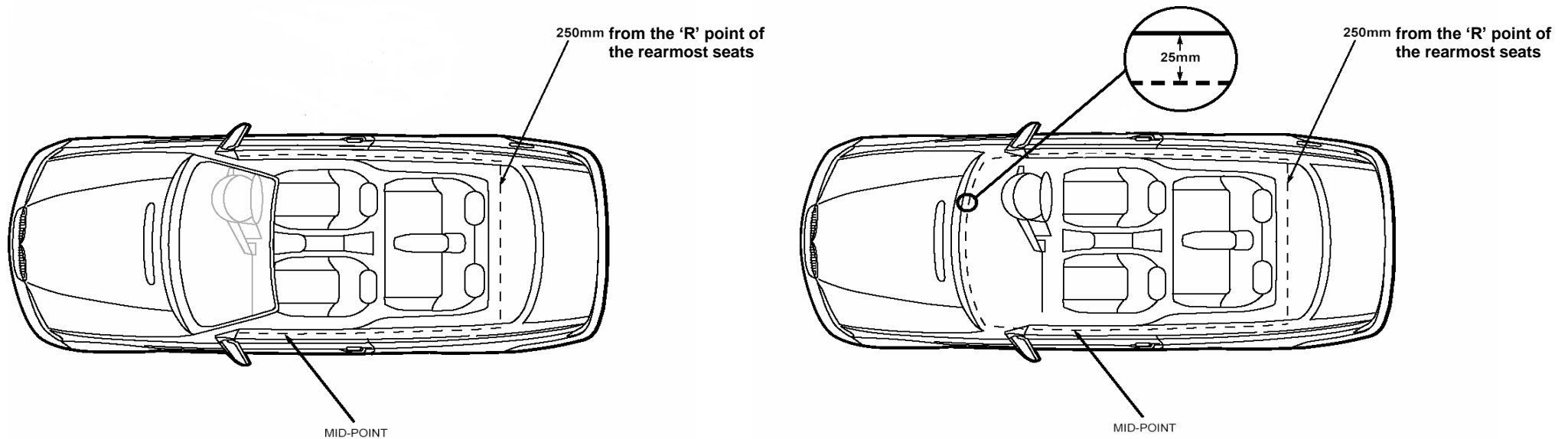

## Exterior Projections 16

## Record of Revision

Revision	Date	Description of Change
1	27/03/2009	
2	24/05/2010	Removed reference to greater than 1.5 mm in RS3, also text figure 1,2 and 3 in annex 1 amended, RS 14 removed as it conflicts with requirements of section 37 of manual also figures 5 and 6 removed in annex 1 MOI amended following discussions with VCA exposed suspension, added new figure 5 Amended MOI to incorporate IVA TSE M1 16 002
3	31/07/2011	Inserted the words 'from the ground' into paragraph 1 on page 1.
		Inserted the words '(Spare wheels must still be assessed when they are externally mounted.)' in paragraph 2 on page 3
4	31/10/2011	Inserted new Note 3 concerning hood or tonneau cover press studs and show link from RS2. Add reference to 'soft' access lids in Annex 2
5	29/04/2012	Correction - reference to 'soft' access lids in Annex 2
6	30/09/2012	Reword Mol paragraph 2 and insert new paragraph 3
7	17/06/2013	Add text to labelling of Annex 2
8	03/10/2016	Hard feature relation to Shore A scale corrected, Note 5 para 4 expanded.

This page intentionally left blank

# 17 Speedometer and Reverse Gear

**Application:** All Vehicles having a maximum speed exceeding 25mph

Method of Inspection	Required Standard																		
<p><b>A vehicle must indicate an accurate speed to the driver at all times and must be capable of travelling in a rearward direction under its own power.</b></p> <p>Where the accuracy of the device is in question, (i.e. any vehicle other than an original unmodified speedometer fitted to an mass produced vehicle which its self has no modifications that would affect the accuracy of the device) and with the vehicle positioned on, or fitted with a speed measurement device, operated to the manufacturer’s instructions, drive the vehicle at a stable speedometer indicated speed of 35mph and note the true speed. Repeat at four more speeds up to and including 70mph as is necessary to confirm compliance.</p> <p>Where the speed of the vehicle cannot be measured with the available equipment it may be necessary for the applicant to demonstrate compliance.</p> <p><b>Note 1.</b> The speedometer must be of a type suitable for M1 vehicle use. The types manufactured for bicycles, racing only, those that rely on GPS or those that require switching as a separate function to that of operating the vehicle or those that have a separate power source from the vehicle or where they do not operate as an automatic function when the vehicle is driven are not permitted. Where the device is in question the presenter may provide evidence as to the suitability of the device for road use from the manufacturer of the device.</p>	<ol style="list-style-type: none"> <li>The vehicle must be fitted with an acceptable type of Speedometer (see <b>Note 1.</b>)</li> <li>A speedometer must be capable of indicating the vehicle speed in miles per hour (mph) at uniform intervals not exceeding 20mph for all speeds up to the maximum design speed of the vehicle. (see <b>Note 2.</b>)</li> <li>The speedometer must be capable of being read at all times of the day or night. (see <b>Note 6.</b>)</li> <li>The speedometer must not indicate a speed less than the true speed.</li> <li>The speedometer must not indicate a speed that is in excess of the true speed plus the permitted tolerance in the chart below. (see <b>Note 3.</b>)</li> </ol> <table border="1" data-bbox="1240 922 1998 1268"> <thead> <tr> <th>Indicated Speed (mph)</th> <th>Min True Speed (mph)</th> </tr> </thead> <tbody> <tr><td>35</td><td>26</td></tr> <tr><td>40</td><td>30</td></tr> <tr><td>45</td><td>35</td></tr> <tr><td>50</td><td>39</td></tr> <tr><td>55</td><td>44</td></tr> <tr><td>60</td><td>48</td></tr> <tr><td>65</td><td>53</td></tr> <tr><td>70</td><td>57</td></tr> </tbody> </table> <ol style="list-style-type: none"> <li>The in use “rest” position for the needle must be between the Zero position and the first marked increment</li> </ol>	Indicated Speed (mph)	Min True Speed (mph)	35	26	40	30	45	35	50	39	55	44	60	48	65	53	70	57
Indicated Speed (mph)	Min True Speed (mph)																		
35	26																		
40	30																		
45	35																		
50	39																		
55	44																		
60	48																		
65	53																		
70	57																		

## Speedometer and Reverse Gear 17

Method of Inspection	Required Standard
<p><b>Note 2.</b> It is acceptable if the maximum speed of the vehicle is indicated by the last increment on the speedometer which must not be more than 19mph beyond the last 20mph increment.</p> <p><b>Note 3.</b> The permitted Tolerance is;</p> $\frac{\text{true speed}}{10} + 6.25\text{mph}$ <p><b>Note 4.</b> “Reverse Gear” A device used to propel the vehicle in a backwards direction under its own power, this does not have to be in the gearbox, it may be a separate component i.e. secondary gearbox / electric motor</p> <p><b>Note 5.</b> DVSA examiner to refer to the DVSA Technical Work Instructions <a href="#">WI-5.4.1-17-01 Speedo Test</a> when carrying out this test.</p> <p><b>Note 6:</b> While the vehicle speed indication must always be readable, the speed unit descriptor need not be illuminated.</p>	<p>7. The vehicle must have an operational reverse gear which can be selected from the driving position. (see <b>Note 4.</b>)</p>

## Speedometer and Reverse Gear 17

## Record of Revision

Revision	Date	Description of Change
1	27/03/2009	
2	31/07/2011	Insert new <b>Note 5.</b>
3	17/06/2013	Revise <b>Note 5.</b>
4	03/10/2016	Update work instruction hyperlink, insert new <b>Note 6.</b> and link from RS 3.

## Speedometer and Reverse Gear 17

This page intentionally left blank



# 18 Statutory Plates

**Application:** All Vehicles

Method of Inspection	Required Standard														
<p>Where a vehicle is subject to a multistage build (completed vehicle), a plate is required on completion of each stage as appropriate. Every plate fitted must display the same VIN as displayed on the chassis. The weight information is only necessary on the chassis manufacturer's plate or on a converters plate if they have altered those weights with any modification. Separate plates should be fitted in close proximity to each other.</p> <p>Check that the manufacturer's plate (in the case of a multistage build, one for each stage) complies with the Required Standards.</p> <p>The manufacturer may give additional information. The approval number and build stage number may be listed below the manufacturer's name. Any other information must be outside a clearly marked rectangle which shall enclose only the listed information.</p> <p>If any of the technically permissible masses are higher than the masses permitted in GB and NI for a vehicle or axle, then there should be 2 columns for masses - in the left hand column the maximum permitted masses in GB/NI, and in the right hand column, the technically permissible masses.</p> <p>The identification number of the base vehicle (VIN) prescribed by Directive 76/114/EEC shall be retained during all the subsequent stages of the type-approval process to ensure the 'traceability' of the process. However, at the final stage of completion, the manufacturer concerned by this stage may replace, in agreement with the approval authority, the first and second sections of the vehicle identification number with his own vehicle manufacturer code and the vehicle identification code if, and only if, the vehicle has to be registered under his own trade name. In such a case, the complete vehicle identification number of the base vehicle must not be deleted.</p>	<ol style="list-style-type: none"> <li>1. The vehicle must be fitted with a manufacturer's plate, in a conspicuous and readily accessible position.</li> <li>2. Manufacturer's plates must be fitted at each stage of a multistage build and be positioned in close proximity to each other.</li> <li>3. The manufacturer's plate(s) must be made of a durable material.</li> <li>4. The manufacturer's plate(s) must be securely attached to a part of the vehicle that will not be replaced through normal use (see <b>Note 3</b>).</li> <li>5. The manufacturer's plate(s) must be indelibly marked with the manufacturer's name (See <b>Note 1</b>)</li> <li>6. All plate(s) must be indelibly marked with the Vehicle Identification Number (VIN) which matches the number marked into the vehicle structure and is displayed in the correct order inside a clearly marked rectangle. (See below and <b>Notes 1, 2 &amp; 5</b>).</li> </ol> <table border="1" style="margin-top: 10px; width: 100%; border-collapse: collapse;"> <tr> <td style="padding: 5px;">DVSA MOTOR INC</td> <td style="padding: 5px;">Name of manufacturer</td> </tr> <tr> <td style="padding: 5px;">e1*2007/46*0291*02</td> <td style="padding: 5px;">Approval No. and/or Build Stage No.</td> </tr> <tr> <td style="padding: 5px;">3GPG918009BS51312</td> <td style="padding: 5px;">Vehicle Identification Number</td> </tr> <tr> <td style="padding: 5px; text-align: center;">1500 kg</td> <td style="padding: 5px;">Maximum permitted laden mass of vehicle</td> </tr> <tr> <td style="padding: 5px; text-align: center;">2500 kg</td> <td style="padding: 5px;">Maximum permitted laden mass for the combination where the vehicle is used for towing</td> </tr> <tr> <td style="padding: 5px; text-align: center;">1 – 730 kg</td> <td style="padding: 5px;">Maximum permitted laden road mass for each axle, listed in order from front to rear</td> </tr> <tr> <td style="padding: 5px; text-align: center;">2 – 810 kg</td> <td></td> </tr> </table>	DVSA MOTOR INC	Name of manufacturer	e1*2007/46*0291*02	Approval No. and/or Build Stage No.	3GPG918009BS51312	Vehicle Identification Number	1500 kg	Maximum permitted laden mass of vehicle	2500 kg	Maximum permitted laden mass for the combination where the vehicle is used for towing	1 – 730 kg	Maximum permitted laden road mass for each axle, listed in order from front to rear	2 – 810 kg	
DVSA MOTOR INC	Name of manufacturer														
e1*2007/46*0291*02	Approval No. and/or Build Stage No.														
3GPG918009BS51312	Vehicle Identification Number														
1500 kg	Maximum permitted laden mass of vehicle														
2500 kg	Maximum permitted laden mass for the combination where the vehicle is used for towing														
1 – 730 kg	Maximum permitted laden road mass for each axle, listed in order from front to rear														
2 – 810 kg															

## Statutory Plates 18

Method of Inspection	Required Standard
<p><b>Note 1:</b> For markings to be considered 'indelible' they should be unlikely to become disfigured or obliterated during the life of the vehicle. Whilst stamping or engraving is preferable it is possible to accept a printed or painted plate providing it has been treated in such a way that it is most unlikely that essential information would be obliterated or defaced during the normal life of the vehicle.</p> <p><b>Note 2:</b> Maximum permitted laden masses are not required to be displayed but if present should be listed in the order as shown in RS6</p> <p><b>Note 3:</b> 'Securely attached' means screwed, bolted, riveted or otherwise fixed such that it is not likely to become displaced during the life of the vehicle.</p> <p><b>Note 4:</b> The spacing of characters must be such that no additional characters could be added at a later date.</p> <p><b>Note 5:</b> Where a vehicle is "mass produced" it is acceptable for the information on the plate to be on separate plates provided that the plates are fitted as close as possible to each other in a clearly visible position and every plate is marked with the vehicle identification number.</p> <p><b>Note 6:</b> Every plate fitted must display the same VIN as displayed on the chassis; vehicles that have been imported from New Zealand may have more than one identification plate.</p> <p><b>Note 7:</b> For Mass-produced vehicles, if originally applied by the manufacturer it may be less than 17 but no less than 8 digits.</p> <p><b>Note 8:</b> Mass produced North American vehicles approved with either FMVSS or CMVSS a visible VIN that can be seen through the windscreen will be acceptable. In these instances there is no requirement to look for a stamped in VIN.</p>	<ol style="list-style-type: none"> <li>7. The Stamped in VIN must be marked on the chassis, frame or other similar structure which is not easily removable, on the right hand side of the vehicle when viewed from the rear. (see <b>Notes 6, 8, 9</b> and <b>12</b>)</li> <li>8. The Stamped in VIN must be placed in a clearly visible and accessible position by a method such as hammering, stamping, etching (metal chassis) or embossed, moulded into the structure (glass fibre or carbon fibre chassis) so that it cannot be obliterated or deteriorate.</li> <li>9. The VIN number must consist of 17 digits with the information shown in a single line (except for mass-produced vehicles where the use of two lines is permissible). See <b>Note 7</b>.</li> <li>10. Capital letters and numerals <b>must</b> be used for the VIN</li> <li>11. There must not be any gaps large enough to insert extra characters between the characters for the VIN shown on the manufacturer's plate or stamped into the vehicle. (See <b>Note 4</b>)</li> <li>12. The Vehicle Identification number on the manufacturer's plate must be marked in characters at least 3.5mm high.</li> <li>13. The characters on the manufacturer's plate (with the exception of the Vehicle Identification Number) must be at least 2 mm high</li> <li>14. The characters used for the VIN stamped into the chassis, frame or other similar structure must be at least 3.5mm high.</li> <li>15. Use of the letter I, the letter O, the letter Q, dashes, asterisks and other special signs are not permitted (see <b>Note 10</b>)</li> <li>16. In instances where the VIN has been changed evidence of agreement with the Approval Authority must be provided.</li> </ol>

## Statutory Plates 18

Method of Inspection	Required Standard
<p><b>Note 9:</b> For mass produced vehicles any location is accepted if originally applied by the manufacturer</p> <p><b>Note 10:</b> For mass produced vehicles the use of asterisks and other signs is permitted if originally applied by the manufacturer.</p> <p><b>Note 11:</b> For instances where the VIN has been changed in accordance with the Approval Authority</p> <p><b>Note 12:</b> Where the 'stamped in VIN' is stamped on to a separate metal plate it must be secured to the frame by a continuous seam weld around the entire length of the plate; tack or spot welding should not be considered an appropriate method of attachment for such a plate. To stamp the number into a tubular chassis member is not always practical but there may be instances where it could be stamped in another similar part of the vehicle structure which is not easily removable.</p>	<p><b>17.</b> The original complete vehicle identification number of the base vehicle must be present on the chassis (see <b>Note 11</b>).</p> <p><b>18.</b> The complete new VIN must be stamped on the chassis as near as possible to the original VIN (see <b>Note 11</b>).</p> <p><b>19.</b> The last eight characters of the new VIN must be identical to the last eight characters of the base vehicle VIN (see <b>Note 11</b>).</p>

## Record of Revision

Revision	Date	Description of Change
1	27/03/2009	
2	09/04/2009	RS6 now includes reference to glass fibre and carbon fibre chassis / RS11 & 12 now includes revised measurement
3	29/06/2009	RS5 now has the text “not easily removable” added
4	24/05/2010	Amend note 3 to account for additional identification plates fitted to vehicles imported from New Zealand
5	31/07/2011	Revised MOI wording and notes, removed ‘Example of manufacturer’s plate’ from Mol on page 2 and inserted new RS 2 and new RS 5 as per N1 IM. ,
6	31/10/2011	Inserted (completed vehicle) in first paragraph of Mol, removed <b>Note 4</b> and renumbered remainder
7	29/04/2012	Inserted new Note 2, renumber remaining Notes and amend RS6.
8	30/09/2012	Amend RS6
9	30/09/2012	Correct RS6
10	17/06/2013	Reverse RS 4 & 5, Revise RS6, link RS5 to note 1 & RS7 to note12, revise RS8 – 14

## 19 Seat Belt Anchorages

**Application:** Vehicles subject to Basic requirements

Method of Inspection	Required Standard
<p><b>Motor-caravan, Ambulance, or Hearse</b> conversions, with a maximum mass equal to or exceeding 2500kg may comply with the applicable requirements of the original base vehicle. Documentary evidence of base or incomplete vehicle approvals will be deemed acceptable provided the maximum mass of the original approvals has not been exceeded.</p> <p>In the case of a <b>Motor-caravan, Ambulance, or Hearse:</b></p> <p>(a) The required standards do not apply to seats intended for use solely while the vehicle is stationary or for when the vehicle is not used on a public road.</p> <p>(b) Any seats which are not for use when travelling on a public road must be clearly identified to users by means of a pictogram or a sign with appropriate text.</p> <p>(c) At least anchorages for lap belts are required for all rear seating positions</p> <p>(d) Seats designed for dual function as sleeper beds should be assessed in the seating mode only.</p> <p>In the case of <b>Armoured</b> vehicles exemption from any requirement of this item is permitted if it can be demonstrated to the satisfaction of the Approval Authority that it is impossible for the vehicle to comply due to its special purpose.</p>	<ol style="list-style-type: none"> <li>1. Each seating position for forward, sideward or rearward facing passengers must have the minimum number of adequate anchorage points. (See <b>Annexes 1 and 2</b>).</li> <li>2. For motor caravans, ambulances hearses and other special purpose vehicles seats are not intended for use when the vehicle is driven on public road must be accompanied with a pictogram or sign clearly indicating that the seat is not to be used whilst the vehicle is in motion.</li> <li>3. The anchorage and surrounding structure must be of adequate strength to withstand the load likely to be imposed in the event of a vehicle frontal impact. (see <b>Annex 2</b>)</li> </ol> <p><b>Wheelchair space</b></p> <ol style="list-style-type: none"> <li>4. Any wheelchair space shall be fitted with the following:             <ol style="list-style-type: none"> <li>(a) A wheelchair and wheelchair user restraint system complying with item 19 of Directive 2007/46/EC, Annex XI, Appendix 3;</li> </ol> <p><b>or</b></p> <ol style="list-style-type: none"> <li>(b) A restraint system comprising:                 <ol style="list-style-type: none"> <li>(i) a four point wheelchair tie-down system suitable for general wheelchair application; and</li> <li>(ii) a wheelchair user restraint system comprising a minimum of three anchorage points to provide a pelvic and upper torso restraint system.</li> </ol> </li> </ol> </li> </ol>

## Seat Belt Anchorages 19

Method of Inspection	Required Standard
<p>Assess the strength of each anchorage and of the surrounding vehicle structure. Materials and construction methods should be taken into account. For seats to which seat belts are directly mounted (integral seat belts) or where part of the seat forms the “effective anchorage” the extra loading imposed on the seat as an anchorage and the extra loading imposed on the seat mountings should be taken into account when assessing item 15 Seat Strength</p> <p>Seat belt anchorage points must comply with the strength and location requirements of Directive 76/115 EEC, or to an equivalent safety standard On seats to which seat belts are directly mounted (integral seat belts) consideration must be given to the seat mounting as a belt anchorage point</p> <p>Materials and construction methods must be taken into account.</p> <p>Comparable methods to that of a known approved vehicle type may be acceptable. Evidence that the vehicle is of identical structure to a vehicle which has been demonstrated to comply with the requirements may be taken to confirm compliance.</p> <p>Vehicles (particularly high capacity vehicles with more than 2 rows of seats) may be fitted with seats that were not produced by the vehicle manufacturer but were produced by or for the vehicle converter, and are of the type used in larger capacity minibuses or buses. (For example pedestal seats or seats having a frame of tubular design onto which the seat belts are mounted). Particular care should be taken to verify that these seats meet the requirements for an M1 category vehicle.</p> <p>Where a vehicle is presented with this type of seat, the presenter will be required to provide evidence that the seats of this type fitted to the vehicle meet the requirements for an M1 category vehicle. This should be in the form of a declaration from the vehicle converter or seat manufacturer making reference to the vehicle concerned, confirming that the seats fitted (other than the original vehicle manufacturer’s seats) meet the strength and positional requirements of Directive 76/115/EEC for a category M1 vehicle, and supported by documentary evidence of the seat test results.</p>	

## Seat Belt Anchorages 19

<b>Method of Inspection</b>	<b>Required Standard</b>
<p>Where the evidence provided relates to the seat only, consideration must be given to the seat mounting as a belt anchorage point.</p> <p><b>Wheelchair space</b></p> <p>An alternative wheelchair tie-down system, docking system or occupant restraint system may be fitted. This may include a rearward facing wheelchair arrangement with appropriate safety features. Evidence must be provided to the Approving Authority that the system offers an equivalent level of occupant protection for the wheelchair user.</p> <p>Wheelchair(s) provided by the presenter for the assessment of the number of wheelchair spaces must be of an appropriate size to those likely to be used with the vehicle.</p>	

**Annex 1 - number of anchorages required**

Table to show minimum number of anchorages required

Vehicle category - effective date	Front facing seat				Rear facing seat	Side facing seat
	Outboard Seat		Centre Seat			
	Front	Other	Front	Other	All	All
Cars	3	3 or 2 See <b>Note 2</b> below	2, see <b>Note 1</b> below	2	2	2
Motor caravan, ambulance	3	2	2, see <b>Note 1</b> below	2	2	2

**Note 1:** The front centre seat will require 3 anchorages where it is the driver's seat or the windscreen is located:

- in the case of a fixed (non-sliding) seat, within 840mm. of the seat reference point
- in the case of a sliding seat, within 840mm. of the seat reference point when the seat is 127mm forward of its rearmost position.

**Note 2:** Outboard seats require a 3 point anchorage unless there exists a passage between a seat and the nearest sidewall of the vehicle intended to permit access of passengers to other parts of the vehicle. A space between a seat and the wall is considered as a passage, if the distance between that sidewall, with all doors closed, and a vertical longitudinal plane passing through the centreline of the seat concerned – measured at the R-point position and perpendicular to the median longitudinal plane of the vehicle – is more than 500mm

**Seat Belt Anchorages 19**



## **Annex 2 - Strength of seat belt anchorages.**

Seat belt anchorages must comply with the strength requirements for M1 vehicles in Directive 76/115/EEC or an equivalent standard. This can be demonstrated in several ways:

1. Evidence of type approval
2. Documentary evidence of testing to the Directive standard
3. Comparison with a type approved vehicle
4. Visual assessment

### 1. Evidence of type approval

Suitable evidence of type approval will be accepted.

### 2. Documentary evidence of testing to the Directive standard.

Suitable documentary proof will be accepted.

### 3. Comparison with a type approved vehicle

Evidence that the vehicle is of identical structure to a vehicle which has been demonstrated to comply with the requirements or which is type approved may be used to confirm compliance.

### 4. Visual Assessment

In the absence of evidence the examiner will have to determine whether the vehicle complies using a visual inspection. See Annex 3

### Annex 3 - Seat Belt Anchorages Strength Assessment

In a severe accident, the seated occupant can exert huge loads upon their seatbelts (in the region of 1.5 tonnes for a 75kg person). Seatbelt anchorages together must withstand these large loads from the seatbelts. These loads in turn must be dissipated by the vehicle structure.

In assessing the strength of the anchorages, it is essential to consider

- the vehicle structure in the immediate vicinity of the anchorage, and
- the parts of the vehicle structure into which the loads from the anchorages will be dissipated.

These large loads will act in several directions as shown in **Figure 1**.

#### All Vehicles

What to look for:

- Evidence that anchorages in a vehicle of the same or a very similar type have been subjected to a seatbelt anchorage strength test to “European Standards” by a recognised authority. This may be acceptable where there is clear evidence that the structure is identical to the vehicle originally tested.
- Welding should appear neat and of good quality; whilst it is impossible to judge the quality of a weld just by looking at it, messy welding is rarely strong welding.
- Bolts used in structural areas should be of grade 8.8 or better. Such bolts will be marked 8.8 or 12.9 on the hexagonal head, however, cap-head bolts or 7/16" ( 11mm ) UNF seat belt anchorage bolts (with an anodised finish) not marked in this way may normally be considered to be of equivalent strength. Bolts should be M8 or larger.
- Threaded bushes should be welded (at both ends) through the tube, and not end mounted on the surface. (A threaded bush may be attached by its side surface to a structural component).

Cause for Concern:

- Welds of poor appearance, gaps or visible lack of penetration.
- Anchorages in thin and/or flat panels with little stiffness or reinforcing structure or in thin walled tube.
- Low grade bolts (less than grade 8.8).
- Insufficient bolt capacity, e.g. number of bolts and/or diameter of bolts

## **Monocoque Construction**

### **Steel Monocoques**

What to look for:

- Structural box sections.

### **Composite Monocoques**

Composite materials such as glass reinforced plastic (GRP - also known as fibreglass) are fairly common in the specialist vehicle industry.

What to look for:

- Box Sections with heavy lay up (i.e. material thickness).
- Reinforced areas, for example using folded metal box sections laminated into the vehicle structure.
- Material lay-up of good quality with absence of air bubbles.
- 7/16" (11mm) UNF threaded fixing of suitable surface area, or welded to a spreader plate of suitable surface area.

Cause for concern:

- Threaded fixing/spreader plate of insufficient surface area.
- Threaded fixing and/or spreader plate only retained by a thin layer of laminate on the outer surface of the structure.
- Material lay-up poor with obvious air bubbles or delamination (separation of material layers).
- Cracking or flexing of structural areas.
- Loads from anchorages being transmitted to weak areas of vehicle.

### **Anchorage on Steel Chassis (See Figure 2)**

What to look for:

- Triangulation and bracing will provide strength and spread the loads effectively into the chassis.
- Upper anchorage must be adequately braced to strong areas of the chassis.
- Threaded seatbelt anchorage fastening should be welded into tubes or onto plates of sufficient thickness.

Cause for Concern:

- Absence of sufficient structure to transmit loads from anchorages.
- Absence of bracing or triangulation from upper anchorage structure.

## **Seat Belt Anchorages 19**

### **Steel Chassis with Anchorages on Roll Cage (See Figure 3)**

What to look for:

- Triangulation and bracing which will provide strength and spread the loads effectively into the chassis.
- The joint where the roll cage joins the chassis and the chassis itself must be sufficiently strong to withstand the loads from the anchorages.
- Upper anchorage must be adequately braced from near the anchorage to strong areas of the chassis.
- Threaded seatbelt anchorage fastening should be welded into tubes or onto plates of sufficient thickness.
- Bolted joints joining the cage to the chassis and parts of the cage to each other should be of sufficient strength.

### **Composite Structural Body with Anchorages on Integral Roll Cage.**

What to look for:

- A combination of the strength characteristics of Composite Monocoques and Steel Chassis with Anchorages on Roll Cage above.
- Where a combination of the strength of the body and cage are used to strengthen the anchorages, body and cage should be joined at regular intervals.

Cause for concern:

- As Composite Monocoques and Steel Chassis With Anchorages on Roll Cage above.

### **Anchorages Integral with Seat Structure**

What to look for:

- Seats where the integral anchorage/s has been previously approved in a vehicle. In this case attention must still be paid to the method of fixing the seat in the vehicle.
- Seats fixed to vehicle structural areas, i.e. box sections etc.
- Use of spreader plates to spread loads into structural areas of the vehicle.
- Where lower anchorages are mounted on the seat structure, they should be welded or permanently fixed to the seat in a structurally strong area.
- Where the upper anchorage is mounted on the seat structure, the seat back must be braced to the lower seat structure. This bracing must begin as close as possible to the upper anchorage.
- Where the upper anchorage is mounted on the seat structure, the seat-to-floor fixing must be substantial to withstand the large leverage imposed upon it.
- Where the seat is mounted on runners, these must be of adequate strength.

## **Seat Belt Anchorages 19**

Cause for concern:

- Seats mounted on flat panels, non-structural areas of vehicle floor or open channel section material.
- Lack of load spreading plates.
- Seat frames constructed of thin wall circular section tube in areas receiving loading from anchorages.
- Upper anchorages on seat back without bracing to strong area of seat.

**Figure 1**

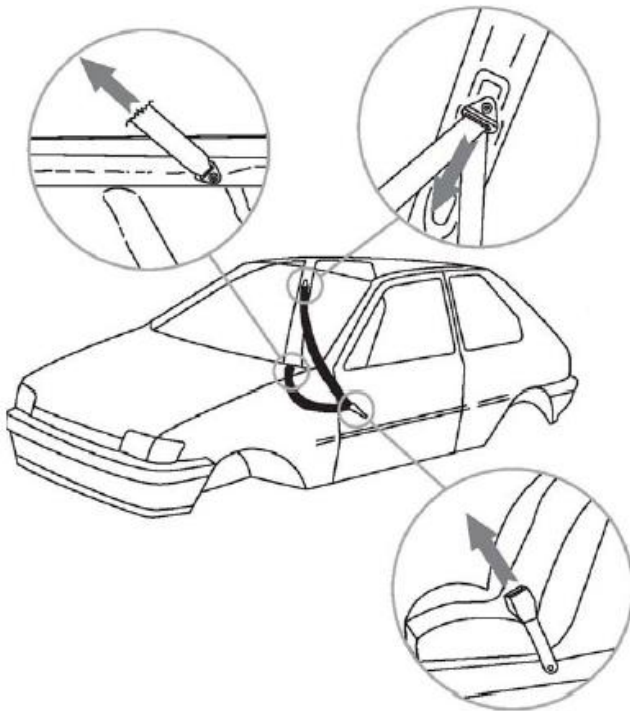

**Figure 2**

Shaded Areas  
Show Important  
Structure.

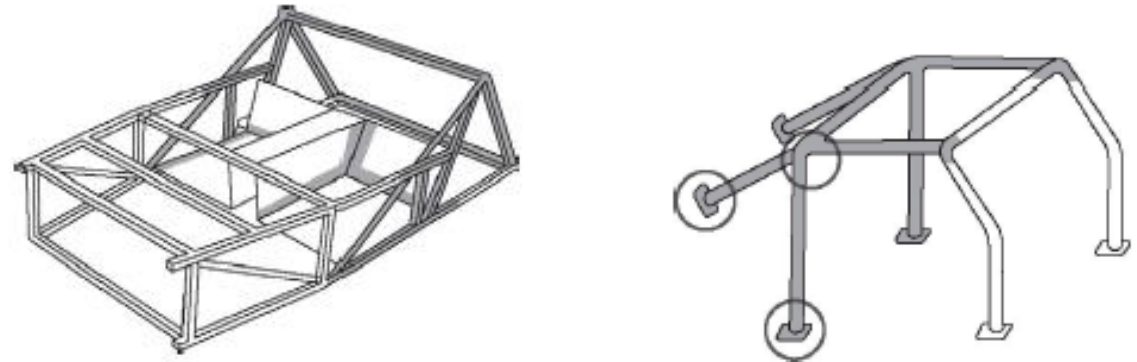

## **Pedestal Seats (seats mounted on box or tubular section legs) with Integral Belt Anchorages**

In this situation, the seat itself becomes part of the belt anchorage and the loads generated on a belt must be dissipated through the seat frame and into the surrounding vehicle structure.

Typical vehicles fitted with such seats might include “People Carriers” and Taxi conversions.

During the anchorage Type Approval test, forces equivalent to approximately 3 tonnes **per seating position** are applied to the belt anchorages of all forward-facing seating positions. In the case of a double or triple seat, this might mean loads approaching the order of 9 tonnes could be transmitted through the seat pedestals and into the vehicle. In a seat with integral anchorages, this load must travel down the seat back and sides, into the pedestals and then into the floor of the vehicle. The height of the pedestals above the floor then acts as a lever causing the front seat legs to be pushed down into the vehicle floor and the rear seat legs to be pulled upwards out of the floor.

Depending on the pedestal height, the forces being fed into the floor could be considerably larger than the 3 tonnes force applied to the seat belts. On pedestals about 350mm high the upward load on the rear seat legs might well be in the region of 6 tonnes (three tonnes per seat pedestal). In view of the extremely high loads, it is important that a thorough assessment of the load path from each anchorage to the vehicle structure is made. This will begin at each of the belt anchorages and might end some considerable distance away from the attachment of the seat to the vehicle. There are a variety of ways in which a vehicle floor can be designed to cope with the loading from a seat with integral belt anchorages. One commonly used method is to secure the seats to a beam or box section or framework inside the vehicle, running the length of the saloon area. This framework is then attached to the vehicle in a variety of places spread over a large area and located close to strong points under the floor (such as junctions between chassis members). Such systems are difficult to inspect once the vehicle is assembled as the structure is normally concealed under a cosmetic “plywood” floor.

Another commonly used method is the use of load spreading plates above and below the vehicle floor. These plates effectively behave as large “washers” spreading the load from the seat pedestals into a surrounding area of vehicle floor.

Some vehicle converters choose to use a system of reinforcing members (typically channel or box section members) under the vehicle floor. The intention is to use these members in the same way as reinforcing members inside the vehicle but without the increase in floor height and loss of headroom. The disadvantage of such a system is that in order to clear under floor obstructions such as chassis members and running gear, the reinforcing members cannot be continuous and must have joints in them – which can weaken the overall structure.

**What to look for:**

## General requirements for all vehicles

- A test certificate from a recognised test authority must be provided to show that the seat itself or the seat and tracking (where this is fitted) is capable of meeting the strength and anchorage positional requirements of the Directive 76/115/EC as amended. It should typically include at least the following information:

Seat make and model, Vehicle category (M1, M2 or M3), Seat type (single/double or triple), Belts fitted (3-point or lap), Pedestal height, Mounting details (i.e. on tracking or rigidly, mounted to a base plate).

- **ALL** the mounting holes provided in each pedestal for securing the seat to the vehicle or tracking must be utilized.
- **ALL** the mounting holes provided to secure any given length of tracking to the vehicle must be utilised.
- All tracking fasteners should be M8 grade 8.8 or better.
- Tracking must be installed in a continuous length without joints.
- Seat or tracking mounting bolts that pass through hollow section reinforcing members should be fitted with “anti crush tubes”.

**NOTE:** Alternative mounting arrangements will be considered satisfactory where satisfactory documentary evidence of compliance can be provided by the vehicle presenter.

**b. Fixed Single Seats**

A typical single seat fixed directly to the vehicle floor is likely to require

- load spreading plates at least 100 x 100 x 4mm thick.
- spreader plates fitted between the front legs and the **inside** of the vehicle floor
- spreader plates between the rear leg securing nuts and the **underside** of the vehicle floor.

Where the rear mounting bolts are located within 50mm of a chassis member, the plate may be folded (not reduced in size) to clear the obstruction and the fold should abut snugly against the chassis member.

Where two or more single seats each having separate pedestals are mounted within approximately 200mm of each other, additional reinforcement should be provided as well as the load spreading plates, or the size and thickness of the load spreading plates increased.

**NOTE:** In many cases the mounting bolts will pass through slotted holes in the load spreading plate to allow for adjustment. Suitable arrangements must be in place (e.g. oversized washers) to prevent the nut or the head of the bolt from pulling through the slot in the plate.

## Seat Belt Anchorages 19

Single seats with integral 3-point belt anchorages attached to the vehicle floor via offset or asymmetrical legs (i.e. to clear a wheel arch,) must be considered on a case-by-case basis. Documentary evidence from the seat manufacturer should be sought to confirm that the seat itself can withstand the forces required by the Directive when tested independently of the vehicle on its offset pedestals.

In vehicles modified to allow rear-access for a wheelchair via a ramp to a lowered central floor section having additional seats fitted either side of the lowered floor section, seats are often mounted directly to the floorpan either with very short pedestals or no pedestals at all. It is common for at least some of the original vehicle's belt anchorages to be used in combination with one or more of the anchorages on the new seat. The inspection should take into account the reduced floor loading resulting both from the shorter pedestals and (if applicable) from the relocation of the upper anchorage from the seat backrest to the vehicle pillar.

Where only **one** lower anchorage is attached to the seat, the effects of the asymmetrical loading should be considered.

Some vehicles, e.g. motor homes and ambulances are equipped with swivel seats which may have some or all the belt anchorages attached to the seat itself. Such seats should only be inspected in their position of normal use when travelling.

### c. Removable Single Seats

Removable single seats may be fitted to either

- “Low Profile” tracking or
- “Heavy Duty” tracking or
- to dedicated clamping mechanisms attached to the floor of the vehicle.

For the purposes of this inspection,

- **Low Profile** tracking can be regarded as any tracking system with a section depth of up to 30mm.
- **Heavy Duty** tracking can be regarded as any tracking system with an overall depth of 30mm or more.

#### **Low Profile** tracking systems

The seat fittings locate in cut-outs in the tracking and lock with either a plunger or “blade” arrangement.

In general, a typical single seat with three-point integral belt anchorages and mounted on a typical pedestal arrangement that is itself Directive compliant is likely to satisfy the Directive requirements as long as the tracking is

- supported in such a way as to prevent excessive distortion of the floor



## Seat Belt Anchorages Strength Assessment

- attached to the vehicle using 8mm (grade 8.8 or better) fasteners no more than approx. 100mm apart.
- either bolted to box or steel channel section and then secured to the vehicle floor, or secured by bolts going through the floor and into channel or box sections on the underside of the vehicle.

**NOTE:** Various proprietary load-spreading plates are marketed for this purpose but these are primarily aimed at the “M2” vehicle market for which the seat belt anchorage test loads are only half as great. Unless documentary evidence is provided to the contrary, simple load-spreading plates or washers should not be regarded as being satisfactory.

- (where secured into steel channel sections) secured into channel section of a minimum nominal size of 50x25x4mm which is orientated with the channel flanges facing downwards.

**NOTE:** The channel ends must be free of sharp edges, which may tear the vehicle floor under load.

Unless the tracking is secured to internal reinforcing members, a check should be made that the same number of fasteners are present above and below the vehicle floor. In cases where a fastener lies above a box section, heat shield, fuel tank or other obstruction, it must pass into an object of similar strength to the other reinforcing members.

- “Self-tapping” screws and “riv-nuts” are not considered as being of equivalent strength (unless documentary evidence can be provided).
- Seats should not be capable of being positioned such that the front or rear edge of either pedestal lies within 200mm of the end of a length of tracking.

### Heavy Duty tracking systems.

Although these differ in appearance, they all share the same principal feature – i.e. a much deeper section than the “low profile” tracking systems. These lengths of tracking have sufficient depth of section to resist the large bending loads applied during a seat belt anchorage test. As such, they generally require no reinforcement between themselves and the inside of the vehicle floor and only minimal reinforcement beneath the vehicle floor. Typically, such tracking is not secured at precisely defined intervals so that the converter is free to choose the pitch of the fasteners to miss underfloor obstructions such as chassis members. Often the tracking is secured by pairs of fasteners – one on each side of the centreline, rather than individual fasteners along its centreline.

Heavy Duty tracking should be secured

- with 8mm grade 8.8 (or better) fasteners at intervals of not more than 250mm.
- with fasteners passing through a mild steel load spreading plate at least 50 x 50 x 4mm thick or an equivalent arrangement.
- such that seats are not capable of being positioned with the front or rear edge of either pedestal within less than 200mm of the first or last group of fasteners securing any length of tracking.

**Seats with dedicated fixings.**

Rear single seats in many mass-produced “people carrier” type vehicles are often removable. In general, these are attached to purpose-made latches set into the vehicle floor. If there is evidence to suggest that such an arrangement is not part of the original vehicle equipment, an assessment of the strength of the assembly should be made by comparison with a similar unmodified assembly.

**Load Spreading Plates**

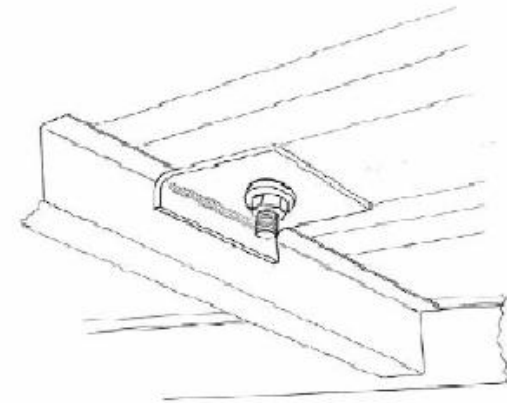
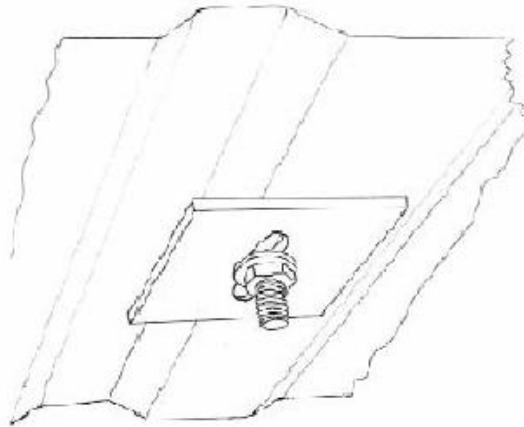
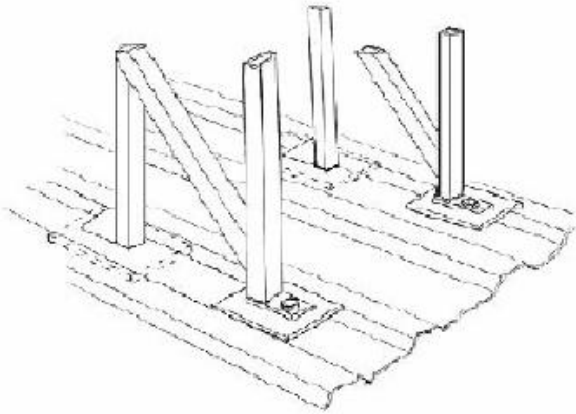

**Low Level Tracking**

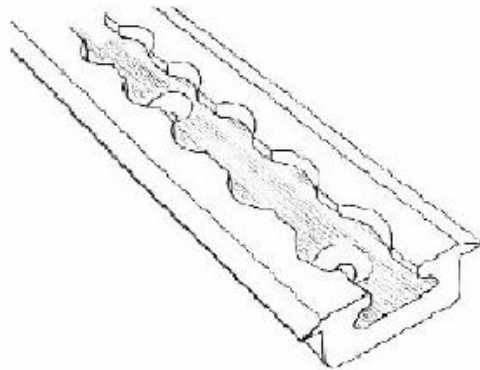

**Heavy Duty Tracking**

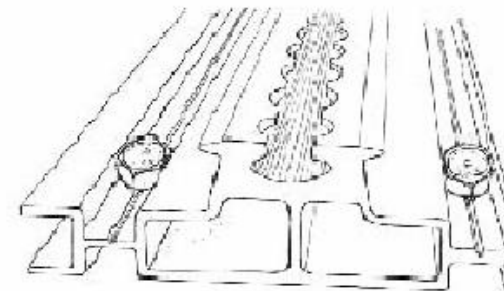

**a. Fixed double seats**

Double seats fitted with integral three-point belts and **two or three pedestals** impart significantly higher loads into the vehicle floor than a single seat imparts. As a result, it is extremely difficult to restrain such a seat using simple reinforcements alone. Documentary evidence that the installation can satisfy the Directive requirements **in-vehicle** should be sought.

Where a double seat with integral three-point belt anchorages is fitted with **four or more pedestals**, approximately evenly spaced, a spreader plate extending at least the full width of the seat should be fitted between the front legs and the vehicle floor. Such a plate might typically be in the region of 5mm thick, 150mm long and at least the width of the complete seat (including cushions).

Angle or channel sections of similar or greater rigidity than the flat plate may also be used.

Where two pedestals are mounted within approx. 200mm of each other, additional reinforcement must be provided as well as the load spreading plates, or the size and thickness of the load spreading plates increased.

**b. Removable double seats**

Removable double seats with three point integral belt anchorages are rare. In general, such a seat fitted with two or three pedestals is unlikely to satisfy the Directive requirements in a vehicle as most currently available tracking systems will not withstand the loads required for a category "M1" vehicle. In all such cases, documentary evidence that the complete seat and tracking assembly has been successfully tested "in-vehicle" should be sought.

**c. Fixed triple seats**

It is common to fit triple seats across the rear of many taxi conversions and "people carrier" vehicles. It is not, generally, possible to secure such seats using simple reinforcements alone. If a triple seat is fitted with three-point integral anchorages, documentary evidence that the complete assembly has been successfully tested "in-vehicle" should be sought.

If some of the belt anchorages are located on the body structure (typically the outboard upper and lower anchorages), the load on the seat mountings will be correspondingly reduced. If the centre seating position is only equipped with a lap belt, the loads on the seat mountings are further reduced. In some cases, only the two anchorages from the centre seat belt and one of the lower anchorages from each of the outboard seating positions will transmit their load into the vehicle through the seat pedestals. Seats fitted with this arrangement of belt anchorages must be assessed on a case-by-case basis. In general terms, such a seat fitted with four pedestals (roughly evenly spaced) is likely to prove satisfactory if fitted with simple load spreading plates. If fewer pedestals are fitted (or more anchorages are located on the seat structure), additional reinforcement will be required.

**d. Rear-Facing seats**

Rear-facing single seats with integral belt anchorages are only required to withstand loads approximately **one third** of the magnitude of a forward-facing seat. As such, mounting arrangements can be significantly less substantial than those for forward-facing seats.

In many cases, rear-facing seats are mounted on a bulkhead rather than free-standing. Often, the bulkhead structure will be impossible to assess due to the presence of trim on both surfaces. In these instances, drawings or photographs of the structure should be sought. The bulkhead structure should be attached to the vehicle at least along its lower edge and sides. An assessment of the strength and number of such mountings should be made. The examiner must satisfy himself (as far as is reasonably practicable) that the attachment(s) of the bulkhead to the vehicle “B” pillars does not compromise the strength of the front seat upper belt anchorages. An inspection of the method used to attach the belt anchorages to the bulkhead (or seats) should also be made. If the belts are attached to the seats, their attachments to the bulkhead will be part of this inspection. It is common to only fit lap belts on rear-facing seats. The removal of an upper belt anchorage significantly reduces the load at the base of the seat during a test. This should be taken into consideration when assessing the structure.

#### **e. Seats with integral Lap Belts**

The fitting of a lap belt rather than a three point belt with its upper anchorage on the seat back is likely to lower the loads on the vehicle floor by approximately one third. For a typical “minibus style” single seat, the load acting to pull the rear legs out of the floor when fitted with a three-point belt is likely to be in the region of 6 tonnes. This would reduce to approximately 4 tonnes if the same single seat were to be fitted with an integral lap belt. In view of the reduction in floor loading, less reinforcement is likely to be required than for a seat with three integral anchorages.

**NOTE:** In cases where three anchorages are provided but only two are attached to the seat, the load on the pedestals could be reduced still further - possibly by as much as half.

#### **f. Sliding Seats**

Some seats are fitted to a system of “runners” so as to allow fore and aft adjustment or to provide two alternative positions of use. Some of the belt anchorages for such seating positions may be attached to the seat. Before making any assessment of the belt anchorages, documentary evidence should be sought to confirm that the seat and runner assembly is capable of satisfying the requirements of the Directive when tested **independently** of the vehicle. Once this has been confirmed, the installation of the seat in the vehicle can be assessed.

## Record of Revision

Revision	Date	Description of Change
1	27/03/2009	
2	28/04/2009	Note added for Japanese vehicles
3	29/06/2009	Note 7 relating to Japanese vehicles removed and table in ANNEX 1 amended
4	24/05/2010	Amended MOI relating to Motor Caravan, Ambulance, Hearse and Armoured Vehicle to clarify and align with RVAR 2009.
5	30/09/2012	Added new paragraph & Notes to wheelchair space Mol plus new RS5 – RS7
6	05/10/2012	Remove Notes 7 & 8 and RS5, 6 & 7 plus amend wording in Wheelchair space paragraph 2.
7	17/06/2013	Insert new paragraphs (c) & (d) in Mol, move Notes 1 & “to Annex 1 and remove note numbering from remainder.

## 20 Installation of Lights

**Application:** All Vehicles

Method of Inspection	Required Standard
<p>The examiner will perform a visual check of all lamps and reflectors fitted to the vehicle, for the correct colour light visible to the front or rear and for any obscured surfaces.</p> <p><b>Exemption from one or more of the technical requirements is permitted for a special purpose vehicle where the special purpose makes it impossible to fully comply provided that all mandatory devices are installed and geometric visibility is unaffected.</b></p> <p>Lamp/reflector <b>lateral position</b> is measured from the extreme outer edge of the vehicle (disregarding tyres, mirrors, lamps and reflectors) to the edge of the illuminated area (or reflective surface on a reflector) nearest that side of the vehicle. Lamp/reflector <b>vertical position</b> is measured from the ground:</p> <p>In the case of the <b>minimum</b> height to the lower edge of the illuminated area (reflective surface on a reflector).</p> <p>In the case of a Dipped Beam headlamp the <b>minimum</b> height will be measured to the apparent trace of the beam cut-off on the lens. If this point cannot be determined then you will take the lower edge of the illuminated area.</p> <p>In the case of the <b>maximum</b> height to the top edge of the illuminated area (reflective surface on a reflector).</p> <p>In the case of lamp or reflector <b>separation</b> the distance must be measured to the edge of the illuminated area (reflective surface on a reflector).</p>	<ol style="list-style-type: none"> <li>1. The vehicle must be fitted with lamps or retro reflective material only capable of showing a white light to the front except for: <ul style="list-style-type: none"> <li>• an amber light from a direction indicator</li> <li>• an amber light from a hazard beacon/warning lamp</li> <li>• a yellow light from a front fog lamp</li> <li>• a yellow light from a front end outline marker lamp</li> <li>• an amber light from a side marker light</li> <li>• ambulances only, a red light from a warning lamp</li> <li>• emergency vehicles only, a blue light from a warning lamp or beacon.</li> </ul> </li>   <li>2. The vehicle must be fitted with lamps or retro reflective material only capable of showing a red light to the rear except for: <ul style="list-style-type: none"> <li>• an amber light from a direction indicator</li> <li>• an amber light from a hazard beacon/warning lamp</li> <li>• a white light from a work lamp, reversing lamp, interior lamp, or a registration plate lamp</li> <li>• a yellow light from a registration plate</li> <li>• an amber light from a side marker light</li> <li>• emergency vehicles only, a blue light from a warning lamp or beacon.</li> <li>• breakdown/recovery or emergency vehicles only, a yellow light from a retro reflective material</li> </ul> </li> </ol>

## Installation of Lights 20

Method of Inspection	Required Standard
<p><b>Rear Fog Lamp to Rear Brake Lamp separation</b> distance must be measured between the “illuminating surface” of each lamp. “Illuminating Surface” should be taken to be the area of the “reflector” to the rear of the bulbs.</p> <p>Where lamps are mounted in a common housing and are “E” marked, the separation criteria should be assumed to be met.</p> <p>The <b>brightness of lamps</b> bearing an appropriate approval mark defines the acceptable standard. Lamps not bearing such a mark should emit light of similar brightness.</p> <p><b>Headlamps</b> should not be compared for brightness, but should emit sufficient light to illuminate the road in front of the vehicle on both main and dipped beams.</p> <p><b>Lamp security</b> - Lamps must be securely mounted to the vehicle, double-sided tape as a method of attachment is to be considered acceptable only in situations where it is the manufacturer's intended method</p> <p><b>Lamp position.</b> Achieving position requirements by masking <b>external</b> parts of the illuminated area is not acceptable. However except for headlamps, <b>internal</b> masking or internal painting of lamp lenses is permitted but this must be permanent and must not affect lamp intensity.</p> <p>Interpretation of the term IMPRACTICABLE/IMPRACTICAL when used in the context of lamp [reflector] position (e.g. “900 or if impracticable 1500”) shall be in line with the following: It shall be deemed impractical to comply with a requirement to mount lamps [reflectors] where no vehicle structure is available for them to be mounted on. On a mass produced vehicle, it shall be deemed impracticable to comply with a requirement that involves moving lamps [reflectors] from their original positions as fitted by the mass production vehicle manufacturer.</p>	<ol style="list-style-type: none"> <li>3. The operation of any lamp must not affect any other lamp or be affected by the operation of any other lamp, unless specifically designed to do so</li> <li>4. All lamps and reflectors fitted to the vehicle must be fixed and not move by swivelling, deflecting or otherwise while the vehicle is in motion, except for: <ul style="list-style-type: none"> <li>• any lamp or reflector which by design can be deflected to the side with the movement of the front wheel or wheels of the vehicle when turned for the purpose of steering the vehicle (See <b>Note 3</b>)</li> <li>• a headlamp for adjustment or dipping of the beam</li> <li>• a headlamp which can be retracted or concealed</li> <li>• a work lamp, used to illuminate a working area or the scene of an accident, breakdown or road works in the vicinity of the vehicle to which it is fitted.</li> </ul> </li> <li>5. All obligatory and optional lamps and reflectors must be securely fitted to the vehicle. Lamp components must be secure and provide an adequate level of performance</li> </ol>

## Installation of Lights 20



Method of Inspection	Required Standard
<p>For the purposes of the test, lamps that are intended to illuminate the road forward of the vehicle are considered to be either;</p> <ol style="list-style-type: none"> <li>a. main beam headlamps (including spot lamps and driving lamps)</li> <li>b. dipped beam headlamps, or</li> <li>c. front fog lamps.</li> </ol> <p><b>Note 1:</b> If a plastic cover over the lamp unit is of a permanent fixing and forms part of the housing of the light unit then this housing will be considered the apparent surface of the lamp</p> <p><b>Note 2:</b> This does not apply to rear retro reflectors which must be visible at all times.</p> <p><b>Note 3:</b> These lamps should be checked with the wheels in the straight ahead position.</p> <p>If workshop tools or equipment are required to reinstate the function of a lamp that 'lamp' should be considered not 'fitted'. If a stop lamp meets the criteria of an optional lamp and is 'fitted', i.e. connected it must operate.</p> <p>Two or more lamps (see "A" and "B" in Figure 4), whether identical or not, having the same function and emitting light of the same colour are considered to be one lamp if the aggregate illuminated area of the lamps occupies 60% or more of the area of the smallest rectangle circumscribing those illuminated areas.</p>	<ol style="list-style-type: none"> <li>6. When every door, tailgate, boot lid, or other movable part is in the fixed open position (any position in which the component will remain, with or without a fixed stay) each of the <ul style="list-style-type: none"> <li>• front and rear position lamps</li> <li>• front and rear indicators</li> <li>• rear retro reflectors</li> </ul> <p>must fulfil one of the following conditions:</p> <ol style="list-style-type: none"> <li>a. half (50%) of the apparent surface (see <b>Note 1</b>) of the lamp or reflector is visible from directly in front of / behind (as appropriate) the vehicle, <b>or</b></li> <li>b. additional fully visible lamp (s) / reflectors satisfying all requirements for the above lamps / reflectors are activated / visible, <b>or</b></li> <li>c. a notice in the vehicle must inform the user that in certain positions of the movable components, other road users should be warned of the presence of the vehicle on the road (e.g. by laying out a warning triangle). See <b>Note 2</b></li> </ol> </li> <li>7. All lamps must emit light of an equivalent brightness and colour when compared to an e approved lamp of the same type</li> </ol>

## Installation of Lights 20

**Figure 1**  
**Horizontal Angles of Visibility**

Each lamp and reflector must be positioned such as to provide an “apparent surface”. At least 50% of the “apparent surface” of each lamp or reflector must be visible from any point within the relevant angles.

Where the front indicator lamp is positioned less than 750mm from the ground the inward angle of visibility may be reduced to 20° when viewed between the vertical angles of visibility shown in Figure 2 ‘a’

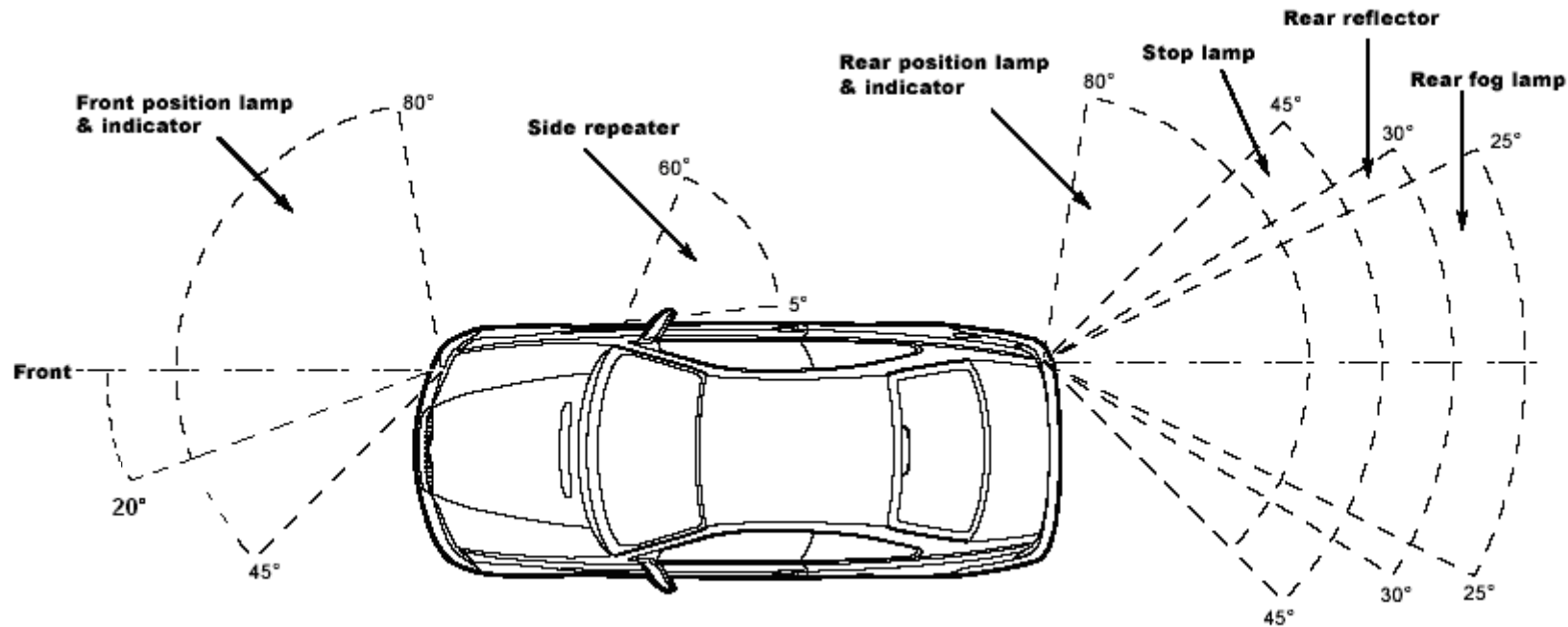

## Installation of Lights 20

**Figure 1A**

In addition, on M1 vehicles less than 6 m in length, side-marker lamps may be used, if they supplement the angles of visibility requirements of front position lamps or rear position lamps where the obligatory lamps do not meet. These marker lamps must be fitted as near to the front / rear of the vehicle as possible and in no case beyond the midpoint of the front / rear wheel arch. These lights are not classified as Side Repeaters

Where the front indicator lamp is positioned less than 750mm from the ground the inward angle of visibility may be reduced to 20° when viewed between the vertical angles of visibility shown in Figure 2 'a'

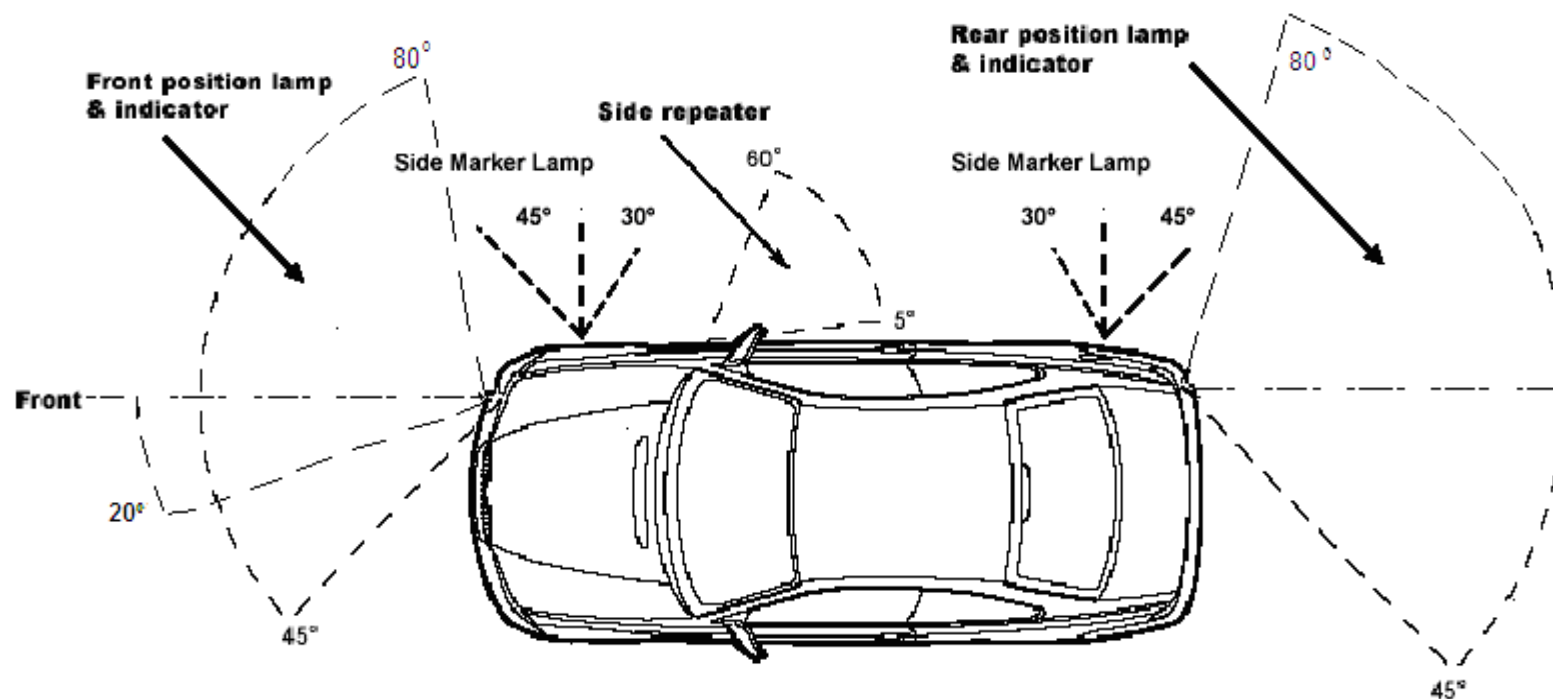

## Installation of Lights 20

## Figure 2 Vertical Angles of Visibility

Front Position Lamps and Indicators (including Side Repeaters)

'a' = less than 750mm above ground level.

'b' = 750mm or more above ground level.

'c' = Rear position lamps and Stop lamps 1500mm or more above ground level. Indicators and Rear reflectors 750mm or more above ground level.

'd' = Rear position lamps and Stop lamps less than 1500mm above ground level.

'e' = Rear position lamps, Stop lamps, Indicators and Rear reflectors less than 750mm above ground level.

'f' = Rear fog lamps.



Each lamp and reflector must be positioned such as to provide an “apparent surface”. At least 50% of the “apparent surface” of each lamp or reflector must be visible from any point within the relevant angles shown

**Figure 3**

“To the rear” of the vehicle means “in an area the sides of which are at an angle of 15 degrees out from the extreme outer edge of the vehicle, (starting from the rear corner) and extending up to **25m** from the rear of the vehicle (measured along the vehicle longitudinal).”

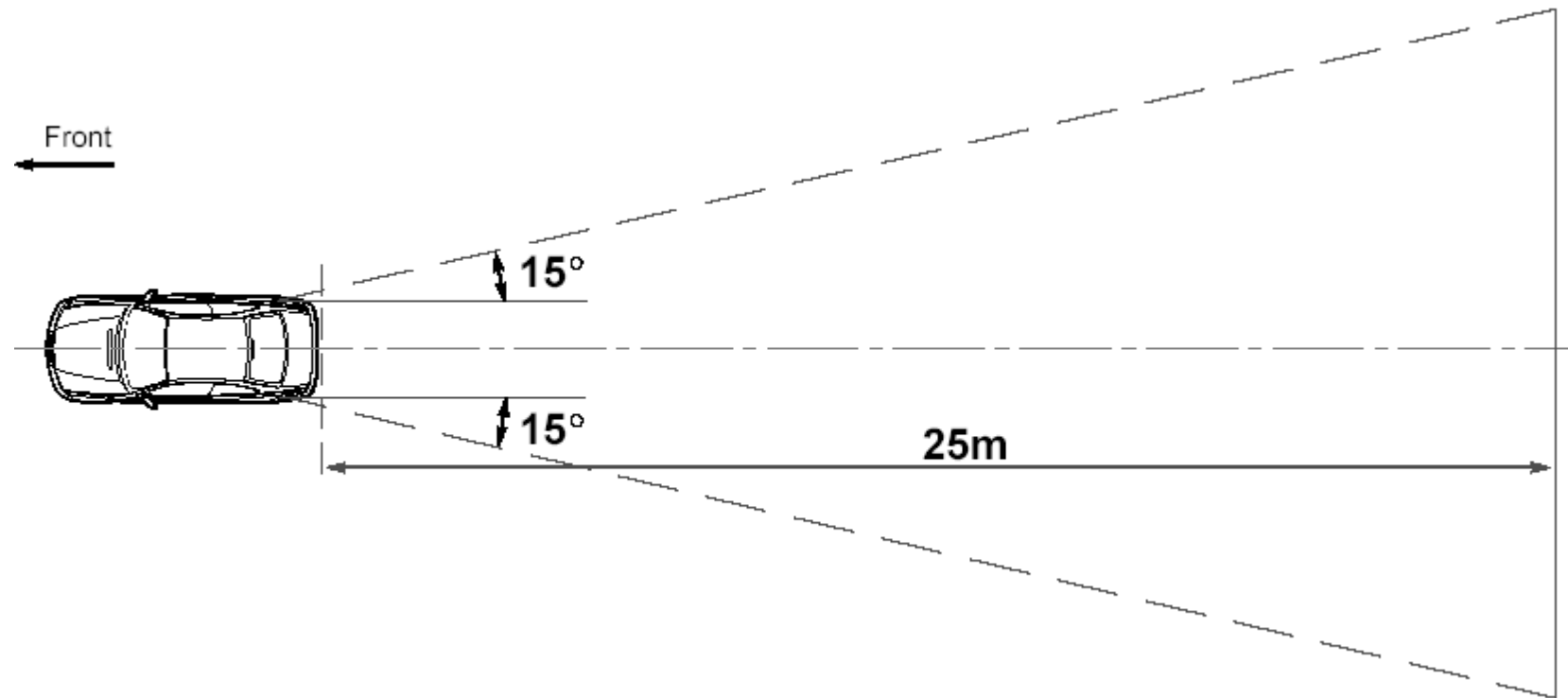

**NOTE:** 15 degrees at 5m distance = 1330mm 15 degrees at 10m distance = 2670mm

No light other than a red light (with the exception of amber light from a direction indicator, white light from a work lamp, reversing lamp, or a registration plate lamp or yellow light from a registration plate lamp) is permitted to be visible in this area.

## Installation of Lights 20

**Figure 4**

If the total of area "A" added to area "B" is 60% or more of the area drawn around the lamps, the lamps are considered to be one lamp.

Smallest rectangle that can be drawn around the two areas "A" and "B"

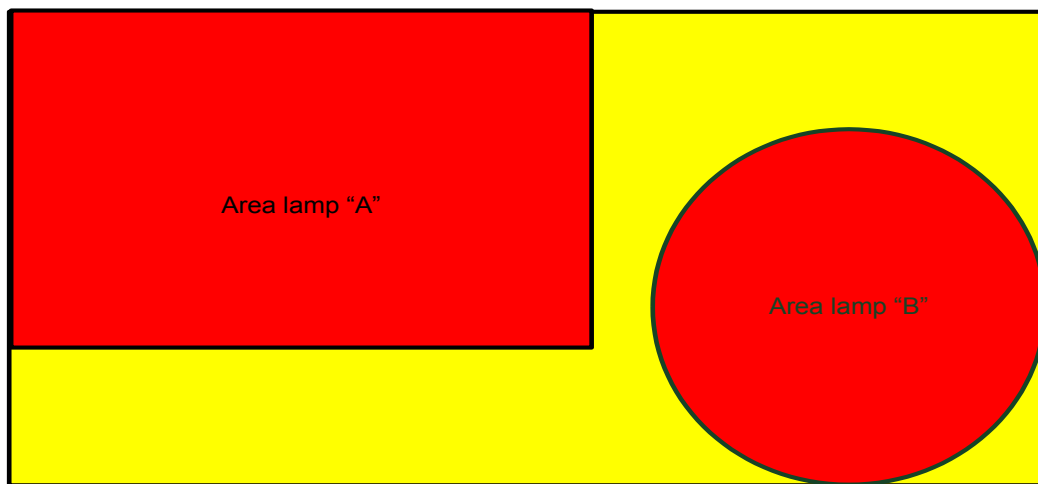

## Record of Revision

Revision	Date	Description of Change
1	27/03/2009	
2	29/06/2009	Positional requirement added to Figure1A Text
3	31/07/2011	Inserted new RS 3 and subsequent RSs renumbered
4	31/10/2011	Inserted new Notes 9 & 10, add link to Note 9 from RS6a, a link to Note 10 from RS 6c, and revise Figures 1 & 1A, front indicator angles of visibility
5	29/04/2012	Revise Figure 1A , front indicator angles of visibility
6	30/09/2012	Revise RS1 & RS2 Revise Figure 1A , rear indicator angles of visibility
7	17/06/2013	Remove numbering from notes 1 – 8, amend note 2, insert new note 3, new paragraphs in Mol., add amber beacon to RS1 & 2 and new Figure 4
8	03/10/2016	Reword Paragraph following note 3. Expand RS5.

This page intentionally left blank



## 21 Retro Reflectors

**Application:** All Vehicles

Method of Inspection	Required Standard
<p>Carry out a visual check of all retro reflectors fitted to the vehicle for colour, number and correct positioning. With optional reflectors check that fitment is permitted</p> <p><b>Triangular rear reflectors (marked with a III, IIIA or IIIB) are only allowed on trailers, they are prohibited on M1. (Reflectors which are close to a triangular shape but are approved for motor vehicles (marked with I, IA, IB, II, IIA, IIB, IV, IVA, IVB) must be accepted.</b></p> <p>Geometric angles of visibility and positional requirements are not required for all optional reflectors.</p>	<p><b>Reflectors;</b></p> <ol style="list-style-type: none"> <li>1. The correct number must be fitted to the vehicle (See <b>Table 1</b>)</li> <li>2. The correct colour must be fitted to the vehicle (See <b>Table 1</b>)</li> <li>3. must be positioned to meet               <ol style="list-style-type: none"> <li>a) the positional requirements of <b>Table 1</b></li> <li>b) the angles of visibility requirements of <b>Table 1</b></li> </ol> </li> <li>4. must be of the correct shape (See <b>Table 1</b>)</li> <li>5. must have similar characteristics when compared to an 'e' marked reflector</li> <li>6. rear reflectors must face predominately to the rear</li> </ol>

## Retro Reflectors 21

Table 1

TYPE	NUMBER	APPLICATION	COLOUR	POSITION			ANGLES OF VISIBILITY
				MAX DISTANCE FROM SIDE (mm)	MAX HEIGHT (mm)	MIN HEIGHT (mm)	
<b>Rear Retro Reflectors Non-triangular</b>	Min 2 Max -any	Mandatory	Red	400	900 or if impracticable 1500	250	a. Horizontal i. 30 <sup>0</sup> inwards and outwards. b. Vertical i. < 750mm above the ground 15 <sup>0</sup> above and 5 <sup>0</sup> below horizontal. ii. otherwise 15 <sup>0</sup> above and below horizontal
<b>Front Retro Reflectors Non-triangular</b>	Min 2 Max -any	optional but if fitted must be in pairs (for concealed headlamps only)	White	400	900 or if impracticable 1500	250	Must face the front
<b>Side Retro Reflectors Non-triangular</b>	Such that rules are complied with see below	Mandatory on vehicles exceeding 6m in length Optional on other vehicles	Amber The rearmost reflector may be red		900mm if impractical to comply 1500 mm	250	a. Horizontal i. 45 <sup>0</sup> inwards and outwards b. Vertical i. <750mm above the ground 15 <sup>0</sup> above and 5 <sup>0</sup> below horizontal. ii. otherwise 15 <sup>0</sup> above and below horizontal
<ul style="list-style-type: none"> <li>• at least one side-reflector fitted to the middle third of the vehicle</li> <li>• the foremost side- reflector being not further than 3 m from the front</li> <li>• the distance between two adjacent side reflectors shall not exceed 3 m if the structure of the vehicle makes it impossible to comply with such a requirement, this distance may be increased to 4 m</li> <li>• the distance between the rearmost side- reflector and the rear of the vehicle shall not exceed 1 m</li> </ul>							

## Record of Revision

Revision	Date	Description of Change
1	27/03/2009	
2	29/06/2009	Altered wording of RS 6 replacing squarely with predominately
3	24/05/2010	Remove 600mm minimum separation distance for rear retro reflectors from table, as per TSE IVA M1 000M1 21 002
4	17/06/2013	Remove note numbering, add the word 'See' to Table 1 in brackets (RS1, 2 & 4)

This page intentionally left blank

## 22 End-outline, Position (Side), Stop, Side Marker & Daytime Running Lamps

**Application:** All Vehicles

Method of Inspection	Required Standard
<p>Carry out a visual check of all outline marker, position, stop, side marker and daytime running lamps fitted to the vehicle for operation, colour, number and correct positioning. With optional lamps check that fitment is permitted and they do not exceed the maximum number of lamps allowed to be fitted</p> <p><b>Note 1:</b> The tell tale must operate with the operation of the position lamp switch, it may be the illumination of the instruments or a separate lamp of any colour (providing it is not likely to confuse the driver) clearly identified in either a pictogram (see section 33) or in a word format.</p> <p><b>Note 2:</b> The inspection of the side marker lamps applies to the obligatory lamps fitted to all vehicles exceeding 6m in length</p> <p><b>Note 3:</b> In addition, on M1 vehicles less than 6 m in length, side-marker lamps may be used, if they supplement the angles of visibility requirements of front position lamps or rear position lamps where the obligatory lamps do not meet.</p> <p><b>Note 4: End Outline Marker Lamps</b></p> <ul style="list-style-type: none"> <li>a. Both front and rear lamps can be combined in one device</li> <li>b. The lights must be a minimum of 200mm from a positional lamp</li> </ul>	<p><b>Front and Rear Position Lamps;</b></p> <ol style="list-style-type: none"> <li>1. The correct number must be fitted to the vehicle (<b>Table 1</b>)</li> <li>2. They must be operational</li> <li>3. They must only emit white light to the front / red light to the rear</li> <li>4. Must be switched on and off by the operation of one switch</li> <li>5. Must have a tell tale fitted. (see <b>Note 1</b>)</li> <li>6. They must be positioned to meet               <ol style="list-style-type: none"> <li>a. the positional requirements of <b>Table 1</b></li> <li>b. the angles of visibility requirements of <b>Table 1</b> (see <b>Note 3</b>)</li> </ol> </li> </ol> <p><b>Stop Lamps;</b></p> <ol style="list-style-type: none"> <li>7. The correct number must be fitted to the vehicle (<b>Table 1</b>)</li> <li>8. They must be operational</li> <li>9. They must only emit red light</li> </ol>

## End-outline, Position (Side), Stop, Side Marker & Daytime Running Lamps 22

Method of Inspection	Required Standard
<p><b>Note 5:</b> The inspection of end-outline marker lamps applies to the obligatory marker lamps fitted to vehicles exceeding 2.10m in width</p> <p><b>Note 6: Daytime running lamps.</b> The lamps must be connected so that they switch off automatically when the headlamps are on. (Except for when the headlamps are flashed).</p> <p>Lamps may be grouped, combined or reciprocally incorporated with one another provided all requirements regarding colour, position, orientation, angles of visibility, electrical connections and other requirements, if any, are fulfilled.</p> <p><b>Note 7:</b> Geometric angles of visibility and positional requirements are not required for all optional position lamps, stop lamps and end outline marker lamps.</p>	<p><b>10.</b> They must only illuminate when the service brake is applied, and must extinguish when the service brake is released</p> <p><b>11.</b> They must be positioned to meet</p> <ul style="list-style-type: none"> <li><b>a.</b> the positional requirements of <b>Table 1</b></li> <li><b>b.</b> the angles of visibility requirements of <b>Table 1</b></li> </ul> <p><b>12.</b> Optional stop lamps must face to the rear</p> <p><b>Side Marker lamps; (if required or optionally fitted)</b></p> <p><b>13.</b> The correct number of mandatory lamps must be fitted to the vehicle if its length exceeds 6m(in accordance to the positional requirements see <b>Table 1</b> and <b>Notes 2</b> and <b>3</b>)</p> <p><b>14.</b> They must be operational</p> <p><b>15.</b> They must emit an amber light ( red will be acceptable if within 1 metre of the rear )</p> <p><b>16.</b> Must be switched on and off by the operation of one switch</p> <p><b>17.</b> They must be positioned to meet</p> <ul style="list-style-type: none"> <li><b>a.</b> the positional requirements of <b>Table 1</b></li> <li><b>b.</b> the angles of visibility requirements of <b>Table 1</b></li> </ul> <p><b>End Outline Marker Lamps; ( if required or optionally fitted)</b></p> <p><b>18.</b> The correct number of mandatory lamps must be fitted to the vehicle ( <b>Table 1</b> and <b>Notes 4</b> and <b>5</b>)</p>

## End-outline, Position (Side), Stop, Side Marker & Daytime Running Lamps 22

Method of Inspection	Required Standard
	<p>19. They must be operational</p> <p>20. They must only emit red light to the rear / white or amber light to the front</p> <p>21. Must be switched on and off by the operation of one switch</p> <p>22. They must be positioned to meet</p> <ul style="list-style-type: none"> <li>a. the positional requirements of <b>Table 1</b> and <b>Note 4</b></li> <li>b. the angles of visibility requirements of <b>Table 1</b></li> </ul> <p><b>Daytime running lamps;</b></p> <p>23. The correct number must be fitted to the vehicle (<b>Table 1</b>)</p> <p>24. They must be operational</p> <p>25. They must only emit white light to the front</p> <p>26. They must be positioned to meet</p> <ul style="list-style-type: none"> <li>a. the positional requirements of <b>Table 1</b></li> <li>b. the angles of visibility requirements of <b>Table 1</b></li> </ul> <p>27. They must extinguish automatically when headlamps are operated. (see <b>Note 6</b>)</p>

## End-outline, Position (Side), Stop, Side Marker & Daytime Running Lamps 22

Table 1

TYPE	NUMBER	APPLICATION	COLOUR	POSITION			ANGLES OF VISIBILITY
				MAX DISTANCE FROM SIDE (mm)	MAX HEIGHT (mm)	MIN HEIGHT (mm)	
Front Position Lamps	Min 2 Max 4 (see <b>Note 7</b> )	Mandatory	White	400	1500 or if impractical 2100	250	a. Horizontal i. 45° Inwards ii. 80° Outwards b. Vertical i. 15° Above and below the horizontal (May be reduced to 5° if the lamps are less than 750mm above the ground)
Rear Position Lamps	Min 2 Max 4 (see <b>Note 7</b> )	Mandatory	Red	400	1500 or if impractical 2100	350	a. Horizontal i. 45° Inwards ii. 80° Outwards b. Vertical i. 15° above and below the horizontal (May be reduced to 5° if the lamps are less than 750mm above the ground)
Stop Lamps	Min 2 Max 4	Mandatory	Red	400	1500 or if impracticable 2100	350	a. Horizontal i. 45° inwards and outwards b. Vertical i. as rear position lamps.
Stop Lamps (Optional)	Min 1 Max 2 (see <b>Note 7</b> )	Optional	Red	If 1 is fitted: as close to vehicle centre-line as practicable If 2 are fitted: no requirement	n/a	no lower than the mandatory stop lamps	Must face the rear
End Outline Marker Lamp	2 visible from the front and 2 visible from the rear Optional Any (see <b>Note 7</b> )	Mandatory on vehicles exceeding 2.10m wide Optional on vehicles 1.80m to 2.10m in width	Front-White or Amber Rear - Red	As close as possible to the extreme edge and not more than 400mm from the edge		Front: No lower than the upper edge of the windscreen Rear: as high as practical, bearing in mind the need to mount the lamps as close as possible to the extreme edge	a. Horizontal i. 80° Outwards b. Vertical i. 5° Above the horizontal ii. 20° Below the horizontal

## End-outline, Position (Side), Stop, Side Marker & Daytime Running Lamps 22



TYPE	NUMBER	APPLICATION	COLOUR	POSITION			ANGLES OF VISIBILITY
				MAX DISTANCE FROM SIDE (mm)	MAX HEIGHT (mm)	MIN HEIGHT (mm)	
Side Marker Lamp	See below	Mandatory where the length exceeds 6m	Amber The rearmost marker may be red if within 1m of rear	-	1500 or if impracticable 2300	250	a. Horizontal i. 45° to the front and rear (Can be reduced to 30° if fitted as an optional extra) b. Vertical i. 10° Above and below the horizontal (The vertical angle below the horizontal may be reduced to 5° if the side marker lamp is fitted less than 750mm from the ground)
Daytime Running Lamp (Optional)	Min 2 Max 2	Optional	White	400mm	1500mm	250mm	a. Horizontal i. 20° Outwards and inwards b. Vertical i. 10° Upwards and downwards

### Side Marker Spacing

- at least one side marker lamp must fitted to the middle third of the vehicle
- the foremost side marker lamp being not further than 3 m from the front
- the distance between two adjacent side marker lamp shall not exceed 3 m if the structure of the vehicle makes it impossible to comply with such a requirement, this distance may be increased to 4 m
- the distance between the rearmost side marker lamp and the rear of the vehicle shall not exceed 1 m

### Positional Requirement for Side Markers used to supplement the angles of Visibility for side lights and directional Indicators

These marker lamps must be fitted as near to the front / rear of the vehicle as possible and in no case beyond the midpoint of the front / rear wheel arch.

## End-outline, Position (Side), Stop, Side Marker & Daytime Running Lamps 22

## Record of Revision

Revision	Date	Description of Change
1	27/03/2009	
2	09/04/2009	Note 6 has been amended
3	29/06/2009	Removed required standard 28 / Add positional requirements for side markers lamps in table 1
4	29/04/2012	Add information to Note 6
5	17/06/2013	Amend Table 1 No. of Stop Lamps

## End-outline, Position (Side), Stop, Side Marker & Daytime Running Lamps 22

## 23 Direction Indicators

**Application:** All Vehicles

Method of Inspection	Required Standard
<p>Carry out a visual check of all direction indicators including side repeater lamps fitted to the vehicle for operation, colour, number and correct positioning. With optional lamps check that fitment is permitted and they do not exceed the maximum number of lamps allowed to be fitted</p> <p><b>Note 1:</b> A tell tale is not required if the front indicators are directly clearly visible to the driver.</p> <p><b>Note 2:</b> The positional and angles of visibility requirements are required to be met when all doors, bonnet, boot lid etc. are in the closed position only.</p> <p><b>Note 3:</b> In addition, on M1 vehicles less than 6 m in length, side-marker lamps may be used, if they supplement the angles of visibility requirements of front indicator lamps or rear indicator lamps where the obligatory lamps do not meet.</p> <p><b>Note 4:</b> Geometric angles of visibility and positional requirements are not required for all optional direction indicators.</p>	<p><b>Directional Indicators and side repeaters;</b></p> <ol style="list-style-type: none"> <li>1. They must be operational</li> <li>2. The correct number must be fitted to the vehicle (<b>Table 1</b>)</li> <li>3. The indicators must flash at a rate of between 60 and 120 times a minute (with all mandatory indicators working, and with the engine running)</li> <li>4. There must be a audible or visual tell tale fitted to indicate the operation of any indicators such that would not cause confusion to the driver (see <b>Note 1</b>)</li> <li>5. All indicators must emit amber light.</li> <li>6. They must be positioned to meet             <ol style="list-style-type: none"> <li>a. the positional requirements of <b>Table 1</b> (see <b>Note 2</b>)</li> <li>b. the angles of visibility requirements of <b>Table 1</b> (see <b>Note 2</b>)</li> </ol> </li> </ol> <p><b>Hazard Warning Lights;</b></p> <ol style="list-style-type: none"> <li>7. Must operate with the ignition switched on and off.</li> <li>8. The hazard warning device must operate all of the direction indicators simultaneously</li> <li>9. The hazard warning device must have a telltale warning light (see <b>Note 1</b>)</li> </ol>

## Direction Indicators 23

Table 1

TYPE	NUMBER	APPLICATION	COLOUR	POSITION			ANGLES OF VISIBILITY
				MAX DISTANCE FROM SIDE (mm)	MAX HEIGHT (mm)	MIN HEIGHT (mm)	
<b>Direction Indicators &amp; Hazard Warning</b>	Motor Vehicles On each side Front – One Rear – One Side Repeater – One (see note 5 below)  Plus 2 optional all vehicles- Rear only (see note 4)	Mandatory	Amber	400 (Min separation 500 unless vehicle width is less than 1400, where Min separation 400) see note 6 below	1500 or if impracticable 2300 for side direction indicators and 2100 for front and rear direction indicators	350	a. Horizontal i. 80° outwards 45° inwards. ii. < 750mm above the ground 20° inwards iii. (SIDE REPEATER) To the rear between 5° and 60° outboard. b. Vertical i. < 750mm above the ground 15° above and 5° below horizontal. ii. Otherwise 15° above and below horizontal.
<b>Note 5:</b> A side repeater lamp must be fitted within 2600 mm of the front of the vehicle							
<b>Note 6:</b> Position/Max distance from side (mm): 400 or in the case of a front indicator on a left hand drive mass produced vehicle - 510 where flashing front side marker lamps are fitted, or in the case of a rear indicator on a left hand drive mass produced vehicle, 480 where it is one of a number of lamps having a common lamp housing.							

## Record of Revision

Revision	Date	Description of Change
1	27/03/2009	
2	29/04/2012	Amend angle of visibility a. (ii) in Table 1

This page intentionally left blank

## 24 Rear Registration Lamps

**Application:** All Vehicles

Method of Inspection	Required Standard
<p>Carry out a visual check of all rear registration plate lamps fitted to the vehicle for operation, colour and correct positioning.</p> <p><b>Note 1:</b> See section 4 Rear Registration Plate Space in conjunction with position of rear registration plate lamp</p>	<p><b>Rear registration plate lamps;</b></p> <ol style="list-style-type: none"><li>1. They must be operational</li><li>2. They must be able to be switched on and off with the front and rear position lights by operating one switch</li><li>3. They must only emit white light</li><li>4. They must be positioned sufficient to illuminate the rear registration plate (See <b>Note1</b>)</li></ol>

## Record of Revision

Revision	Date	Description of Change
1	27/03/2009	
2	28/02/2011	Removed reference to optional lamps in method of inspection.
3	17/06/2013	Link RS4 to note 1



## 25 Headlamps

**Application:** All Vehicles

Method of Inspection	Required Standard
<p>Carry out a visual check of all headlamps fitted to the vehicle for operation, colour, number and correct positioning.</p> <p>With optional lamps check that fitment is permitted and they do not exceed the maximum number of lamps allowed to be fitted</p> <p><b>Conversion of HID headlamps to Halogen Operation</b> There is no official guidance on this type of conversion. Assess the conversion against the required standards 1 to 8 and the relevant headlamp aim standards, plus the security of the lamp <b>and its components</b> against section 20 RS 5.</p> <p><b>Note 1:</b> The “Main Beam” tell tale can either blue in colour, or a tell tale (any colour - preferably blue) with the symbol (see section 33) or a tell tale any colour and the words Main Beam or Main</p> <p><b>Note 2:</b> In the case of a left hand drive vehicle where the headlamp height above the ground does not exceed 850mm, the requirement for headlamp cleaning shall not apply.</p> <p><b>Note 3:</b> Where vehicles are fitted with Gas Discharge or LED Headlamps, the requirement for automatic headlamp self-levelling system or self-levelling suspension shall be deemed to be complied with where evidence is provided at application stage that the vehicle meets the requirements of</p>	<p><b>Headlamps;</b></p> <ol style="list-style-type: none"> <li>1. All obligatory and optional headlamps must be fitted as “matched pairs”.</li> <li>2. They must be operational</li> <li>3. They must be fitted in the correct orientation as would be on an approved vehicle.</li> <li>4. They must emit a white light.</li> <li>5. When on dip or main beam they must emit sufficient light to be able to illuminate the road in front of the vehicle</li> <li>6. The correct number must be fitted to the vehicle (<b>Table 1</b>)</li> <li>7. Dipped beam headlamps must be positioned to meet the requirements of Table 1</li> <li>8. There must be a tell tale when on Main Beam. (see <b>Note 1</b>)</li> </ol> <p><b>Gas Discharge and LED Headlamps</b></p> <ol style="list-style-type: none"> <li>9. Must be accompanied by evidence of compliance with the technical requirements if not compliant with the following: <ul style="list-style-type: none"> <li>• is "E" or "e" marked</li> <li>• dipped beam remains on when main beam is on (gas discharge only)</li> <li>• is fitted with a wash system (see <b>Notes 2</b> and <b>4</b>)</li> <li>• is fitted with an automatic headlamp self levelling system or self levelling suspension (see <b>Note 3</b>)</li> </ul> </li> </ol>

## Headlamps 25

Method of Inspection	Required Standard
<p>6.2.6.1.2 of ECE Regulation 48.03 in all loading conditions.</p> <p><b>Note 4:</b> Where vehicles are fitted with Gas Discharge or LED Headlamps there is no requirement for headlamp cleaning if the light output is below 2000 Lumens (evidence must be provided).</p> <p>Align the headlamp aim testing equipment to the vehicle in accordance with the manufacturer's instructions (In instances where it is not possible to conform to this guidance due to characteristics of the vehicle under test, examiners should position the headlamp tester as close as practicable to the headlamp under test). Check the alignment of each dipped beam headlamp in association with the appropriate criteria.</p> <p>Headlamps producing a flat dip beam are acceptable, and will not have to meet the aim criteria for "break point".</p> <p><b>Note 5:</b> The alignment requirement must be met without the use of masks or beam converters unless they are an integral part of the headlamp as it was approved. Devices or materials applied to the inside of a headlamp which were not present at the time of approval are unacceptable.</p> <p>Some vehicles may be fitted with an in-car driver's headlamp adjustment device. This may be adjusted to enable both headlamps to meet the criteria. <b>Both</b> headlamps, however, must comply with the requirements with the device set in <b>one</b> position.</p>	<p><b>Headlamp Aim (see Note 5);</b></p> <p><b>European Type; ( checked on dipped beam )</b></p> <p>10. The beam image 'kick-up' must not be to the offside.</p> <p>11. For headlamps with centres not more than 850mm from the ground, the beam image horizontal cut-off must be between the horizontal 0.5% and 2% lines, i.e. the red tolerance band.</p> <p>12. For headlamps with centres more than 850mm from the ground, the beam image horizontal cut-off must be between the horizontal 1.25% and 2.75% lines, i.e. the blue tolerance band.</p> <p>13. The beam image 'break point' must not be to the right of the 0% vertical line, or to the left of the vertical 2% line.</p> <p><b>British American; ( checked on main beam )</b></p> <p>14. The 'hot spot' centre must not be above the horizontal 0% line.</p> <p>15. The 'hot spot' centre must not be to the right of the vertical 0% line, or the left of the vertical 2% line.</p> <p>16. For headlamps where the centre is not more than 850mm from the ground, the 'hot spot' centre must not be below the horizontal 2% line.</p> <p>17. For headlamps where the centre is more than 850mm from the ground, the 'hot spot' centre must not be below the horizontal 2.75% line</p> <p>18. When switched from Main beam to dipped beam the image must "Dip" to the left.</p>

## Headlamps 25

Method of Inspection	Required Standard
<p><b>Note 6:</b> American headlamps that dip to the right are deemed to have met this requirement as long as all of the upper edge of the beam pattern is between the dip beam parameters.</p>	<p><b>British American; ( checked on dipped beam ) (see note 6)</b></p> <p><b>19.</b> The upper edge of the 'hot spot' must not be above the horizontal 0% line.</p> <p><b>20.</b> The upper edge of the 'hot spot' must not be below the horizontal 2.75% line.</p> <p><b>21.</b> The right hand edge of the 'hot spot' must not be to the right of the vertical 0% line, or to the left of the vertical 2% line.</p>

### European Type Headlamp

Checked on Dipped Beam

Check the position of the 'break point' and horizontal cut-off.

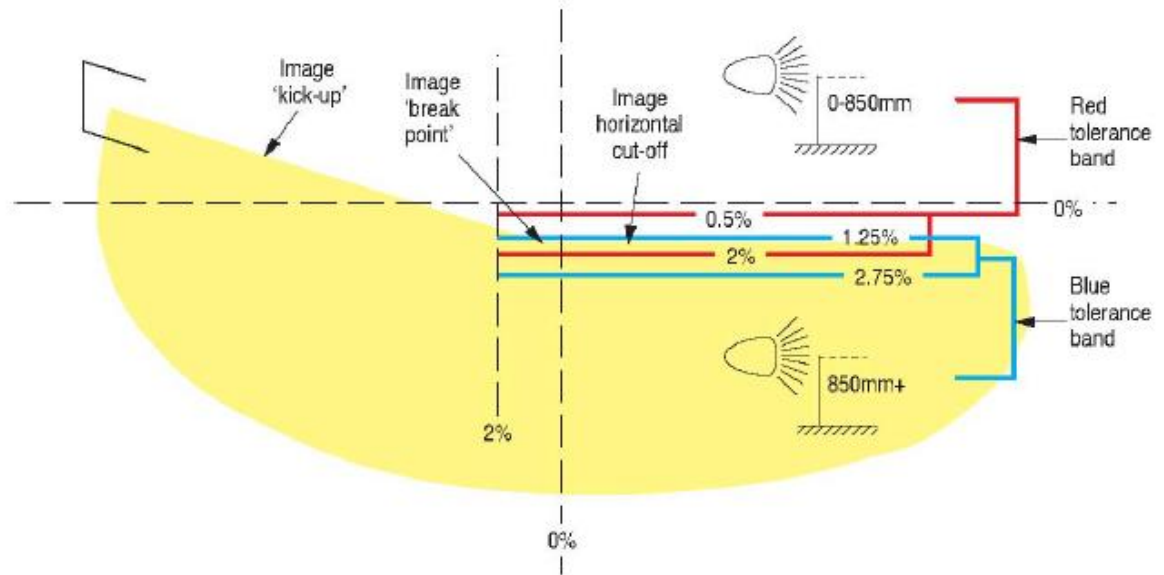

### British American Headlamp

Checked on Main Beam

Check the position of the centre of the area of maximum intensity ('hot spot').

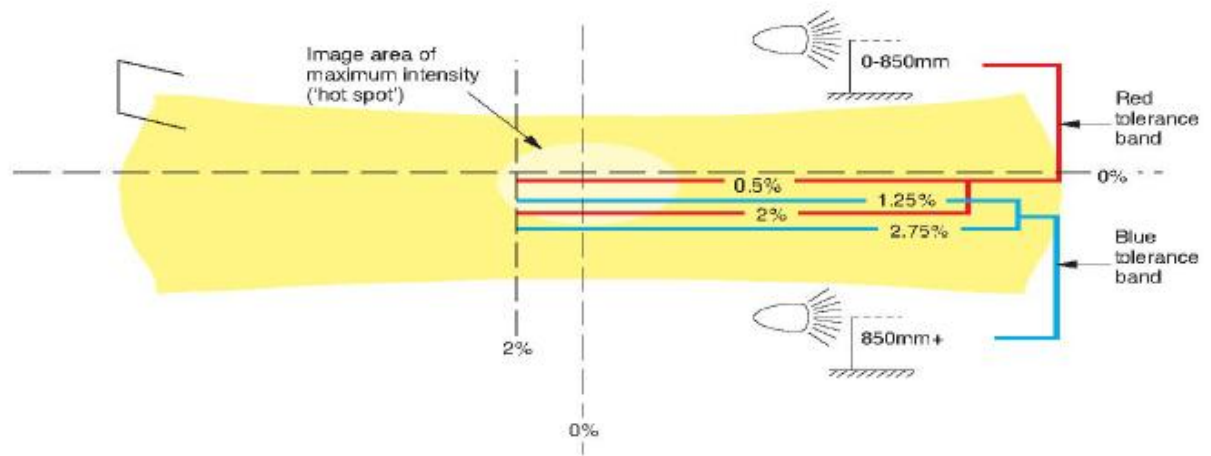

British American Headlamp  
Checked on Dipped Beam

**Check** the position of the upper and right hand edge of the area of maximum intensity ('hot spot').

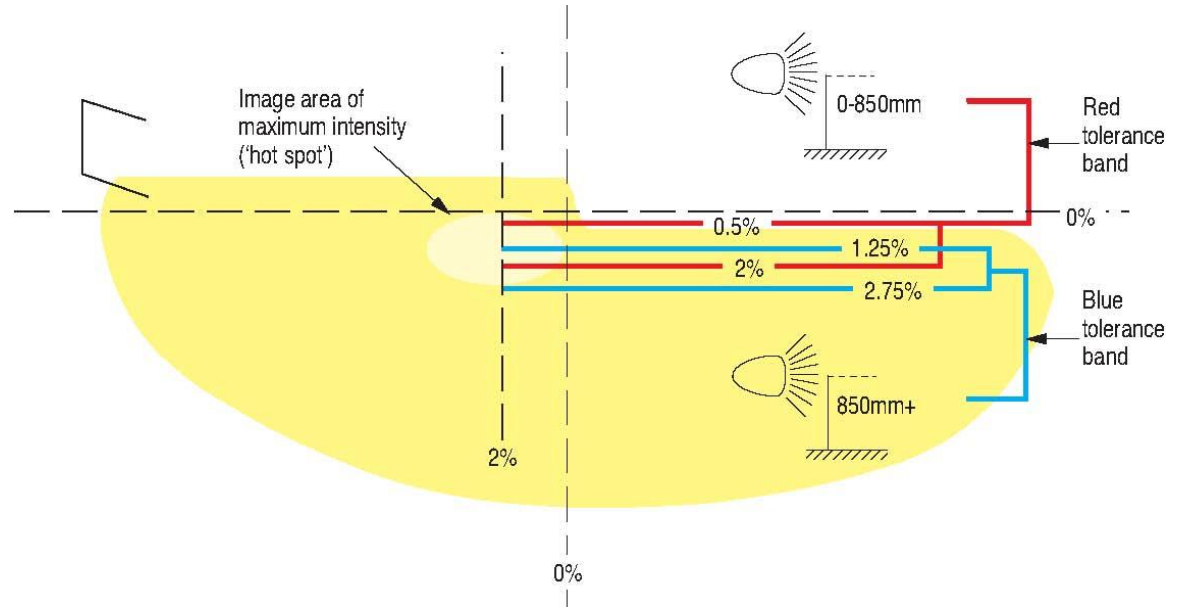

Table 1

TYPE	NUMBER	APPLICATION	COLOUR	POSITION			ANGLES OF VISIBILITY
				MAX DISTANCE FROM SIDE (mm)	MAX HEIGHT (mm)	MIN HEIGHT (mm)	
Dipped Beam Headlamp	Min 2 Max 2	Mandatory	White	400	1200	500	45° out 10° in 15° up 10° down
Main Beam Headlamp	Min 2 Max 4	Mandatory	White	-	-	-	NO REQUIREMENT

## Record of Revision

Revision	Date	Description of Change
1	27/03/2009	
2	28/02/2011	Amend section relating to gas discharge headlamps to include LED systems, note 3 wording amended
3	31/07/2011	Amend section relating to gas discharge headlamps to include new Note 4 and procedures in RS 8 if vehicle not compliant.
4	31/10/2011	Add information in Note 4 ref. aligning headlamp aim tester
5	29/04/2012	Insert reference to Note 5 in Headlamp Aim RS
6	03/10/2016	New paragraph in MOI relating to headlamp conversion

This page intentionally left blank



## 26 Front Fog Lamps

**Application:** All Vehicles (Optional)

Method of Inspection	Required Standard
<p>Carry out a visual check of all front fog lamps fitted to the vehicle for operation, colour, number and correct positioning</p> <p><b>Note 1:</b> This may be achieved by an unlit pictogram (see section 33) or appropriate words, the tell tale may be any colour provided it cannot be confused with any other tell tale.</p> <p><b>Note 2:</b> A tell tale can be taken to include any marking of a switch or control which clearly defines its function.</p> <p><b>Note 3:</b> It is acceptable on some vehicles that when switching on the main beam headlamps the front fog lamps may be extinguished.</p>	<p><b>Front fog lamps;</b></p> <ol style="list-style-type: none"> <li>1. The correct number must be fitted to the vehicle (<b>Table 1</b>)</li> <li>2. They must be operational</li> <li>3. They must only be able to be switched on when the front and rear position lights are also switched on and must be able to be switched independently (see <b>Note 3</b>).</li> <li>4. They must only emit white or yellow light</li> <li>5. Must be fitted with a tell tale (see <b>Note 2</b>)</li> <li>6. Either the switch or tell tale must clearly indicate that operation relates to the front fog lights. (see <b>Note 1</b>).</li> <li>7. They must be positioned correctly to meet the positional requirements of <b>Table 1</b></li> </ol>

**Table 1**

TYPE	NUMBER	APPLICATION	COLOUR	POSITION			ANGLES OF VISIBILITY
				RECOMMENDED MAX DISTANCE FROM SIDE (mm)	MAX HEIGHT (mm)	MIN HEIGHT (mm)	
Front Fog Lamps	Two (Maximum)	Optional	White or Yellow	400	800 max, however No higher than the <b>top edge</b> of the dipped beam headlamp	250	

## Front Fog Lamps 26

## Record of Revision

Revision	Date	Description of Change
1	27/03/2009	
2	23/07/2009	Amend positional requirements in Table 1 to align with RVAR 2009
3	24/05/2010	Amend wording as per TSE IVA 000M1 28 001 and amend required standards to reference Table 2 in section 28 (rear fog lights) to aid understanding of requirements for both examiners and presenters.
4	31/10/2011	Insert new Note 2, link to RS5 and amend wording for RS3
5	30/09/2012	Revise RS3, Insert new Note 2 and renumber all notes

## 28 Rear Fog Lamps

**Application:** All Vehicles

Method of Inspection	Required Standard
<p>Carry out a visual check of the rear fog lamps fitted to the vehicle for operation, colour, number and correct positioning. This includes optional lamps.</p> <p>With optional lamps check that fitment is permitted and they do not exceed the maximum number of lamps allowed to be fitted.</p> <p><b>Note 1:</b> This may be achieved by an unlit pictogram (see section 33) or appropriate words, the tell tale may be any colour provided it cannot be confused with any other tell tale.</p> <p><b>Note 2:</b> This does not apply to mass produced vehicles where there is evidence of either FMVSS or CMVSS approval:</p> <ul style="list-style-type: none"> <li>• when the fog lamp has been produced by conversion of a brake lamp,</li> </ul> <p><b>or</b></p> <ul style="list-style-type: none"> <li>• evidence that the lamp gives suitable intensity has been provided.</li> </ul> <p><b>or</b></p> <ul style="list-style-type: none"> <li>• In the case of North American produced vehicles the lamp gives equal intensity to the stop lamps.</li> </ul>	<p><b>Rear fog lamps;</b></p> <ol style="list-style-type: none"> <li>1. They must be operational</li> <li>2. The correct number must be fitted to the vehicle (<b>Table 1</b>)</li> <li>3. They must only emit a red light</li> <li>4. The rear fog lamp(s) must only illuminate when dipped beam, main beam or front fog lamps are lit (see alternatives in <b>Notes 3</b> and <b>4</b>).</li> <li>5. They must be positioned correctly to meet             <ol style="list-style-type: none"> <li>a) the positional requirements of <b>Table 1</b></li> <li>b) the angles of visibility requirements of <b>Table 1</b></li> </ol> </li> <li>6. Must be fitted with an operational “tell-tale” lamp (non-flashing) visible from the driving position</li> <li>7. Either the switch or tell tale must clearly indicate that operation relates to the Rear Fog lights (see <b>Note 1</b>).</li> <li>8. Must not be operated by a brake control</li> <li>9. Fitted so that the reflector is facing squarely to the rear</li> <li>10. An optional rear fog lamp must form a matched pair with the obligatory lamp.</li> </ol>

## Rear Fog Lamps 28

Method of Inspection	Required Standard
<p><b>Note 3:</b> front fog lamps may be illuminated with the side lamps only.</p> <p><b>Note 4:</b> Either of the following scenarios will also be considered acceptable:</p> <ul style="list-style-type: none"> <li>The rear fog lamp(s) may continue to operate until the position lamps are switched off, and the rear fog lamp(s) must then remain off until deliberately switched on again or,</li> <li>An audible warning, additional to the mandatory tell-tale light, must be activated if the ignition is switched off or the ignition key is withdrawn and the driver's door is opened, whether the lamps in (RS4) are on or off, whilst the rear fog lamp switch is in the "on" position.</li> </ul>	<p>11. An optional rear fog lamp must only operate with the obligatory rear fog lamp</p> <p>12. All rear fog lamps must display an "e" or "E" mark with a "B" or "F" (see <b>Note 2</b>)</p>

Table 1

TYPE	NUMBER	APPLICATION	COLOUR	POSITION			ANGLES OF VISIBILITY
				MAX DISTANCE FROM SIDE (mm)	MAX HEIGHT (mm)	MIN HEIGHT (mm)	
Rear Fog Lamp	Min 1 Max 2	Mandatory	Red	At least one must be on centre line or to offside of vehicle (Min separation distance from stop lamp 100)	1000 When grouped with any rear lamp this may be increased to 1200	250	a. Horizontal i. 25° inwards and outwards; if two lamps are fitted it is sufficient if one lamp (not necessarily the same lamp) – is visible throughout the range b. Vertical i. 5° above and below horizontal.

## Rear Fog Lamps 28

## Record of Revision

Revision	Date	Description of Change
1	27/03/2009	
2	29/06/2009	Split required standard 3 into three separate required standards to aid understanding.
3	24/05/2010	Amend wording as per TSE IVA 000M1 28 001 and amend required standards to reference Table 2 to aid understanding of requirements for both examiners and presenters.
4	26/07/2010	Amend table 3
5	28/02/2011	Amend table 3 to allow front fog lights to switch off when main beam is operated, amend Note 2 to clarify intent
6	31/07/2011	Add bullet point to Note 2
7	31/10/2011	Remove tables 2 & 3, add new Note 3 and amend RS4
8	17/06/2013	Insert new Note 4 and link to RS4.
9	03/10/2016	Amend first statement in Note 4, amend max height in table. Reword RS4

This page intentionally left blank

## 29 Reversing Lamps

**Application:** All Vehicles

Method of Inspection	Required Standard
<p>Carry out a visual check of the reverse lamps fitted to the vehicle for operation, colour, number and correct positioning.</p> <p><b>Scene Lamps</b> whose primary function is to illuminate a working area to the rear of a vehicle when it is stationary are acceptable when fitted on emergency service vehicles or other vehicles designed for use as incident support/recovery vehicles. These lamps may be connected to the reversing lamps to aid night time reversing manoeuvres.</p>	<p><b>Reverse lamps;</b></p> <ol style="list-style-type: none"> <li>1. They must be operational</li> <li>2. The correct number must be fitted to the vehicle (<b>Table 1</b>)</li> <li>3. They must emit white light.</li> <li>4. They must be positioned to face the rear</li> <li>5. They must operate by selection of reverse gear, or be fitted with a telltale warning device.</li> <li>6. Where two lamps are fitted they must be fitted symmetrically and be a matched pair.</li> </ol>

**Table 1**

TYPE	NUMBER	APPLICATION	COLOUR	POSITION			ANGLES OF VISIBILITY
				MAX DISTANCE FROM SIDE (mm)	MAX HEIGHT (mm)	MIN HEIGHT (mm)	
Reversing Lamps	Min 1 Max 2	All Vehicles up to 6000mm	White	No requirement	1200	250	To the rear
	Min 2 Max 4 (includes optional lamps)	Vehicles with a length exceeding 6000mm					

## Reversing Lamps 29

## Record of Revision

Revision	Date	Description of Change
1	27/03/2009	
2	17/06/2013	Add information regarding Scene Lamps
3	03/10/2016	Revise Table 1, max number of lamps



## 30 Parking Lamps

**Application:** All Vehicles (Optional)

Method of Inspection	Required Standard
<p>Carry out a visual check of all parking lamps fitted to the vehicle for operation, colour, number and correct positioning. With optional lamps you must check that their fitment is permitted and they are not exceeding the maximum number of lamps allowed to be fitted</p> <p>The functioning of parking lamps may also be performed by simultaneously switching on the front and rear position lamps on one or the other side of the vehicle.</p> <p><b>Note 1:</b> An operational parking lamp system is to be considered acceptable if the presented vehicle is over 6 metres long/2 metres wide only when it has been built in more than one stage and the parking lamp system was approved at the base vehicle stage.</p> <p><b>Note 2:</b> The parking lamp(s) and, if applicable, the front and rear position lamps must be able to operate even if the device which starts the engine is in a position which makes it impossible for the engine to operate.</p> <p><b>Note 3:</b> The parking lamp(s) on the same side of the vehicle may be lit independently of any other lamps. For example when a vehicle is parked on the left hand side of the road the right hand front and rear position lamps or the dedicated right hand parking lamp(s) may be illuminated and vice versa at the discretion of the driver.</p>	<p><b>Parking lamps;</b></p> <ol style="list-style-type: none"> <li>1. They are not permitted on vehicles that exceed 6 metres in length, or 2 metres in width. (See <b>Note 1</b>).</li> <li>2. They must be operational (See <b>Notes 2</b> and <b>3</b>).</li> <li>3. The correct number must be fitted to the vehicle (<b>Table 1</b>)</li> <li>4. They must only emit red light to the rear / white light to the front</li> <li>5. They must be positioned to meet             <ol style="list-style-type: none"> <li>a. the positional requirements of <b>Table 1</b></li> <li>b. the angles of visibility requirements of <b>Table 1</b></li> </ol> </li> <li>6. The switch must allow the parking lamp(s) on the same side of the vehicle to be lit independently of any other lamps</li> <li>7. A device which automatically deactivates these lamps as a function of time is prohibited</li> <li>8. A closed circuit tell-tale for the parking lamps is optional. However, if a tell tale is fitted it must not be possible to confuse it with the tell tale for the front and rear position lamps</li> </ol>

## Parking Lamps 30

**Table 1**

TYPE	NUMBER	APPLICATION	COLOUR	POSITION			ANGLES OF VISIBILITY
				MAX DISTANCE FROM SIDE (mm)	MAX HEIGHT (mm)	MIN HEIGHT (mm)	
<b>Parking Lamps</b>	Either 2 front and 2 rear Or 1 lamp on each side	Optional on Motor Vehicles not exceeding 6m in length and 2m in width Prohibited on other vehicles	Front – White Rear - Red	400mm from the edge			a. Horizontal i. 45° Outwards, forwards and rearwards b. Vertical i. 15° Above and below the horizontal (The vertical angle below the horizontal may be reduced to 5° if the lamp height is less than 750mm)

## Record of Revision

Revision	Date	Description of Change
1	27/03/2009	
2	17/06/2013	Insert Note 1 and link to RS2
3	03/10/2016	Insert new Notes 1 & 3 and renumber old Note 1 as Note 2. Link RS1 to Note 1 and RS2 to Notes 2 & 3

This page intentionally left blank

## 31 Seat Belts

**Application:** All Vehicles

Method of Inspection	Required Standard
<p>Disabled person belts are seat belts which have been specially designed or adapted for use by an adult or young person suffering from some physical or mental impairment, intended for use solely by such a person and as such are exempt the requirements of this section, however the belt must be securely attached and appear to operate as intended.</p> <p><b>Motor-caravan, Ambulance, or Hearse</b> conversions, with a maximum mass equal to or exceeding 2500kg may comply with the applicable requirements of the original base vehicle. Documentary evidence of base or incomplete vehicle approvals will be deemed acceptable provided the maximum mass of the original approvals has not been exceeded.</p> <p>In the case of a <b>Motor-caravan, Ambulance or Hearse:</b></p> <p>(a) The requirements in column 2 do not apply to seats intended for use solely while the vehicle is stationary or for when the vehicle is not used on a public road.</p> <p>(b) Any seats which are not for use when travelling on a public road must be clearly identified to users by means of a pictogram or a sign with appropriate text.</p> <p>(c) Seats designed for dual function as sleeper beds should be assessed in the seating mode only.</p> <p>In the case of <b>armoured vehicles</b> exemption from any requirement of this section is permitted if it can be demonstrated to the satisfaction of the Approval Authority that it is impossible for the vehicle to comply due to its special purpose.</p>	<ol style="list-style-type: none"> <li>1. Each seat requiring a belt must be fitted with a seat belt of the appropriate type. (see <b>Annex 1</b>)</li> <li>2. For motor caravans, ambulances hearses and other special purpose vehicles where seats are intended for use when the vehicle is driven on public road are required to be fitted with seatbelts. Other seats must be marked with a pictogram or sign clearly indicating that the seat is not to be used whilst the vehicle is in motion.</li> <li>3. Each seat belt must bear the appropriate approval marks or have the equivalent characteristics to that of a belt approved for the same category of vehicle to ensure the belt meets the required approval standards. (see <b>Notes 1</b> and <b>4</b>)</li> <li>4. Each seat belt must be attached by an appropriate fixing and be securely fitted (see <b>Notes 2</b> and <b>3</b>)</li> <li>5. There must be no damage to the seat belt structure that would affect its strength.</li> <li>6. The lock mechanism must securely lock the belt</li> <li>7. The lock mechanism must be able to be released easily, both in normal use and when the belt is under load.</li> <li>8. With the seat belt fastened and the seat unoccupied, retractor mechanisms must take up any excess webbing. (see <b>Note 5</b>)</li> </ol>

## Seat Belts 31

Method of Inspection	Required Standard
<p>Check that whilst sitting in each seat in turn, and wearing the seat belt, secured and correctly adjusted, that the position of the webbing on the torso and the location of the <b>effective belt anchorage</b> points in relation to the seated body position are correct. In the case of a standard mass produced vehicle there will be no need to sit in each seat and assess the fit of the belt on the torso.</p> <p><b>Figure 1</b></p>  <p>It is considered acceptable for an airbag label to be displayed on only one side of a sun visor</p>	<ol style="list-style-type: none"> <li>9. A retractor mechanism must be correctly positioned to ensure the correct operation of the belt (see <b>Notes 6</b> and <b>7</b>)</li> <li>10. The seat belt must sit correctly across the wearers torso so as to provide effective restraint in the event of a frontal impact (see <b>Notes 9, 10</b> and <b>11</b>)</li> <li>11. There must not be any sharp edges / objects in the seat belt area likely to cause damage to the belt.</li> <li>12. The seat belt must be able to be stored so it is always readily accessible to use (see <b>Note 12</b>)</li> <li>13. Where an airbag is fitted in front of a passenger position, a warning label for the airbag must be permanently fixed to the vehicle</li> <li>14. The warning label for the airbag must be visible in front of a person about to install a rearward facing child restraint (<b>Figure 1</b>)</li> <li>15. The warning label for the airbag must be visible when the door is closed otherwise a permanent reference elsewhere that is visible at all times is required.</li> <li>16. A harness or three point belt “effective upper anchorage” location must be at least 450mm above the reference point. (see <b>Figure 2</b>)</li> <li>17. A lap/diagonal belt “effective upper anchorage” location must be at least 140mm from the longitudinal centre line of the seat. (see <b>Note 13</b>)</li> <li>18. The lower anchorages must be at least 350mm apart.</li> </ol> <p>The lower anchorages on side ward facing seats must be at least 350mm apart but no further apart than 500mm.</p>

Figure 2



**Note 1:** A British Standard BS3254 Part 1 1988 or evidence of FIA 8853-98 approval for a harness belt is acceptable

**Note 2:** A suitable single bolt fixing of adequate strength would be, for example, a bolt of at least 11mm (7/16") diameter of grade 8.8 (the grade may not be shown on a bolt produced for a seat belt anchorage). Other bolt fixings may be acceptable providing they are of equivalent strength. Two adjacent seat belts may be secured by one bolt. In this case consideration must be given to the additional loads on the anchorage

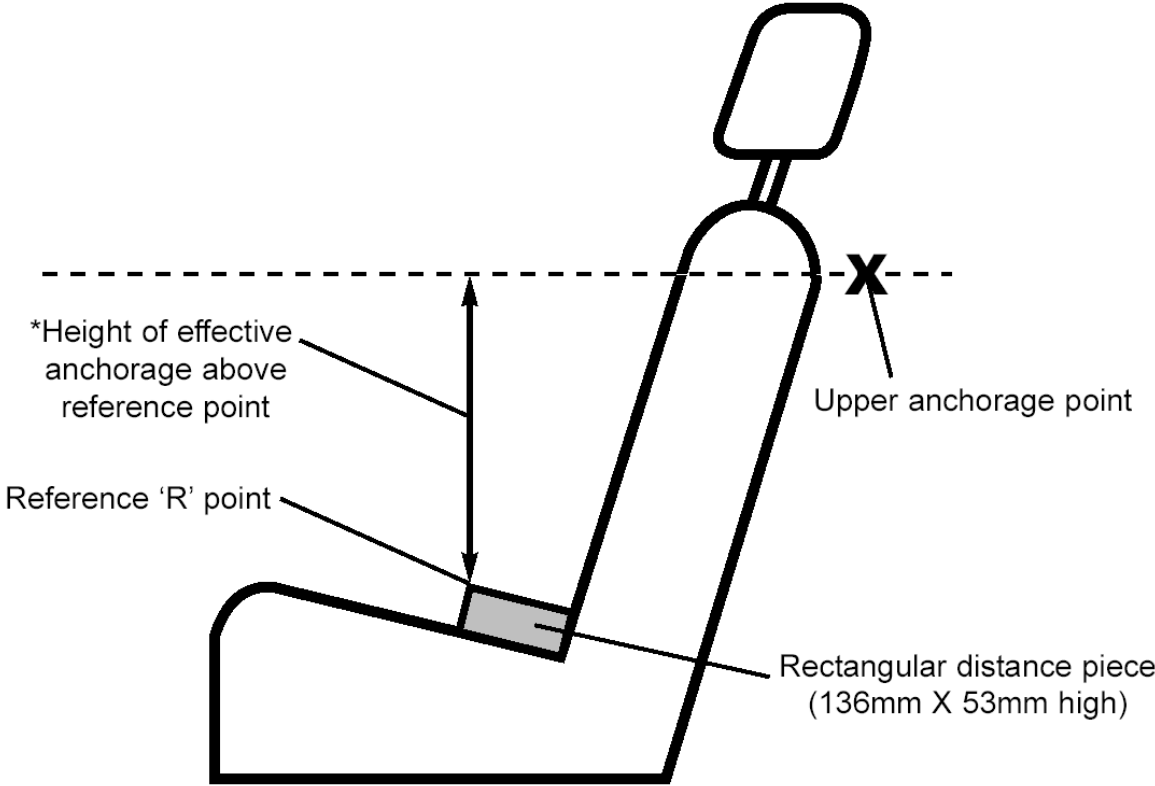
**Note 3:** In order that a seat belt can be separated from the anchorage without causing damage to the anchorage, for example a mounting in the side of a tube or box section, it is a requirement that the bolt is secured into a "fixed" threaded hole or captive nut. (The presenter may be required to demonstrate this condition is met). The bolt may be secured into an alternative fixing, e.g. a lock nut of suitable strength, where access is provided to the "rear" of the mounting to enable separation/re-attachment of the belt.

**Note 4: Characteristics include**

The webbing is of an equivalent type of material and where it is likely to come into contact with the body of the wearer is at least 46mm (33mm in the case of harness belt shoulder straps) in width.

All components are suitably protected against corrosion, e.g. plated or coated.

The locking mechanism, i.e. the buckle, when both under load and not under load, can be released by a single movement in one direction by either hand.

Other than a harness belt the locking mechanism contact area with the body of the wearer is not less than 46mm in width.

For a static seat belt there is a manual adjusting device

- accessible to the wearer when seated
- convenient and easy to use
- capable of being tightened with one hand.

For a retracting belt, the retractor locks when the vehicle is subject to deceleration, tilt or the belt is pulled quickly from the retracting mechanism

**Note 5:** Some types of retracting belt might need help before they retract and harness belts due to their design will not retract however excess webbing must be secured.

**Note 6:** A belt may be fitted with retractor mechanisms on both lap and diagonal sections. If fitted with a single retractor mechanism it must act initially on the diagonal (shoulder) section.



**Note 7:** An “automatically locking” retractor (i.e. one that allows extension of the belt to the desired length and when the buckle is fastened locks on retraction but then prevents subsequent forward movement by the wearer, unlike a typical inertia reel belt), is not permitted unless the feature is only provided after **full extension** of the belt from the retractor, i.e. for use as a child restraint.

**Note 8:** The seat belt must be capable of effectively restraining the occupant

- by the position of the lap belt (due to anchorage location) passing over the pelvic region
- in the case of a harness belt or three point belt, by being positioned across the shoulder so that it does not slip off the shoulder of the occupant.

**Note 9:** Where the seat is adjustable, this check must be carried out with the seat secured in the rearmost position and with the back rest in the normal driving position, in any case at a rearward angle of not more than approximately 25° from the vertical.

**Note 10:** The **effective belt anchorage** is the actual anchorage point to the vehicle unless a change of direction of the belt to the wearer is produced by a fixed intermediate device, for example, a belt guide fitted to the upper part of a seat back.

**Note 11:** Where a seat incorporates a belt guide that creates the “effective belt anchorage” consideration must be given to the strength of the seat back in relation to the loading to which it may be subject, (this being dependent on the position of the actual anchorage). The requirements Section 19 RS 3 should be applied to the effective anchorage location

**Note 12:** An independent belt storage facility is only necessary where it is needed to ensure the belt is always accessible for use.

**Note 13:** The “effective anchorage” is any point where the load from a belt would be applied; consideration should be made to the suitability of the seat to withstand the loads likely to be imposed.

**See section 19**

**Annex 1 Seat Belts – Minimum Obligatory Requirements see note 2****NOTE: “EFFECTIVE DATE”**

In the case of a mass produced vehicle: The date of manufacture of the vehicle (evidence may be required).

In any other case: The date of the examination

The table lists the minimum required belt type.

A 3 point retractor belt may be fitted where the minimum required is a 2 point lap belt and an acceptable alternative to any of the seat belt types listed is an adult harness belt comprising a lap belt and shoulder straps providing the anchorages satisfy section 19.

Vehicle category - effective date	Front facing				Rear facing Seat	Side facing Seat
	Outboard Seat (See note 4)		Centre Seat			
	Front	Other	Front	Other	Other	All
Cars	3 Point retractor belt (See note 3)	3 Point retractor belt (see note 2 below)	2 Point lap belt (see note 1 below)	2 Point lap belt	2 Point lap belt	2 Point lap belt
Motor caravan, ambulance and hearse	3 Point retractor belt (See note 3)	2 Point lap belt	2 Point lap belt (see note 1 below)	2 Point lap belt	2 Point lap belt	2 Point lap belt

**TABLE NOTE 1:** The front centre seat will require 3 anchorages where it is the driver's seat or the windscreen is located

- in the case of a fixed (non-sliding) seat, within 840mm. of the seat reference point
- in the case of a sliding seat, within 840mm. of the seat reference point when the seat is 127mm forward of its rearmost position.

**TABLE NOTE 2:** Outboard seats require a 3 point anchorage unless there exists a passage between a seat and the nearest sidewall of the vehicle intended to permit access of passengers to other parts of the vehicle. A space between a seat and the wall is considered as a passage, if the distance between that sidewall, with all doors closed, and a vertical longitudinal plane passing through the centreline of the seat concerned – measured at the R-point position and perpendicular to the median longitudinal plane of the vehicle – is more than 500mm

**TABLE NOTE 3:** '3 point belt' means a seat belt which,

- restrains the upper and lower parts of the torso
- includes a lap belt and a retractor that operates on the diagonal part
- is anchored at not less than three points, and
- is designed for use by an adult.

**TABLE NOTE 4:** Outboard seats are seats closest to the vehicle sides.

## Record of Revision

Revision	Date	Description of Change
1	27/03/2009	
2	28/04/2009	Note added for Japanese vehicles
3	29/06/2009	ANNEX 1 Table Note 6 relating to Japanese vehicles removed and table amended
4	24/05/2010	Removed reference to RS 8 in MOI as per TSE IVA 000M1 31 002, Note 1 amended, removed reference to BS3254:1960 as it is not present RVAR 2009, note 6 amended in line to ensure that harness belts are not failed for not retracting.
5	30/09/2012	Amend RS3
6	17/06/2013	Insert new paragraph (c) on page 1, insert text in Fig.1, remove note 2, insert text in Annex 1.
7	03/10/2016	Amend note reference in RS 10 & 12, remove references to Note 14, add Note reference to RS17.

## 32 Forward Vision

**Application:** All Vehicles

Method of Inspection	Required Standard
<p>Check that when seated in the driving position, the driver has a full un-obscured view of the road to the front and forward of the near side and offside of the vehicle (90° each side of straight ahead). The lower edge of the forward field of view must not be above the “windscreen horizontal plane” as defined in Annex 1 of this section</p> <p><b>In the case of unmodified Mass Produced vehicles the standards in this section shall be considered to be met.</b></p> <p><b>Where evidence suggests that the vehicle has been modified, the examiner shall assess whether the modification would be likely to materially affect the performance of the relevant component or system, and if so, carry out assessment against the RS</b></p> <p><b>Note 1:</b> The following items do not constitute an obstruction to the field of Vision. This is not an exhaustive list but provided as guidance:</p> <ul style="list-style-type: none"> <li>• “A” pillars and split screen dividers</li> <li>• Central windscreen stay or support (no wider in diameter than 10mm)</li> <li>• fixed or movable vent or side window division bars</li> <li>• outside radio aerials</li> <li>• rear view mirrors</li> <li>• windscreen wipers</li> <li>• “radio aerial” conductors not exceeding the following width; <ul style="list-style-type: none"> <li>○ embedded conductors – 0.5mm.</li> <li>○ printed conductors – 1.0mm</li> </ul> </li> <li>• defrosting and demisting conductors not exceeding 0.03mm visible width</li> <li>• steering wheel rim / instrument panel within wheel rim where highest part of rim is at least 1° below the horizontal (obtained as in Annex 1 of this section by substitution of 1° in place of 4°).</li> </ul>	<ol style="list-style-type: none"> <li>1. The driver must have a clear and un-obscured view of the road ahead and to 90° each side of straight ahead. (See <b>Note 1</b>).</li> </ol>

## Forward Vision 32

**Annex 1**

The “horizontal plane” is obtained by Measuring / projecting a line through a series of datum points from the driving position to its point of intersection with the windscreen or to the road ahead. The driver’s seat, if adjustable, should be adjusted to its rearmost / lowest position.

- c. In the case of a seat with an adjustable back rest, the measurements should be made with the seat back rest adjusted to an angle of 25°, line ‘A’ being parallel to the centre line of the seat back rest.
- d. In the case of a seat with a fixed back rest, the dimensions ‘A’ and ‘B’ should be as follows. A=562.5mm

The “horizontal plane” is at the point where the projection of line ‘C’ intersects the windscreen / windshield, or if above the windscreen / windshield, the vertically projected plane of the windscreen / windshield (line ‘D’).

Where the “horizontal plane” intersects Glazing at any point the Glazing is determined to be a windscreen. The vehicle will therefore be required to meet the standards of section 34 defrost/demist and section 35 wash/wipe.

Angle	‘A’	‘B’
15° - 19°	582.5mm	178.8mm
20° - 24°	572.0mm	182.6mm
25° - 29°	562.5mm	187.2mm
30° - 34°	553.4mm	191.3mm
35° - 39°	543.5mm	194.9mm
40° +	534.1mm	198.8mm

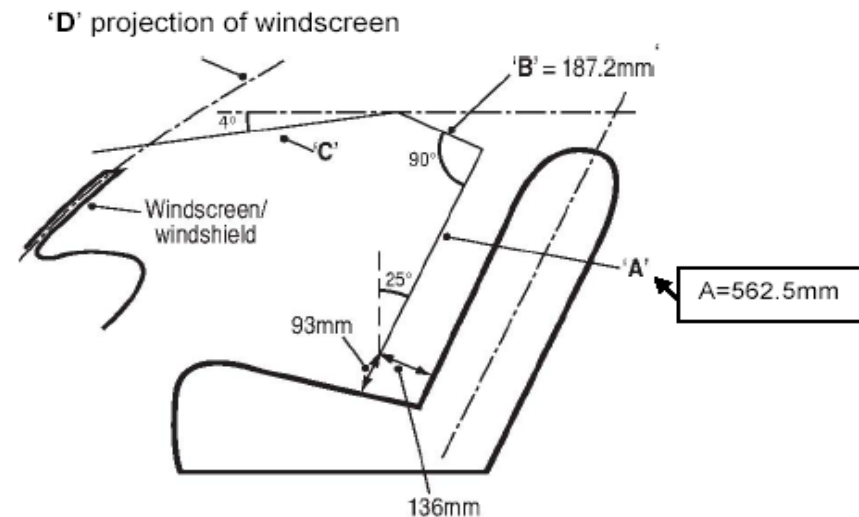

## Record of Revision

Revision	Date	Description of Change
1	27/03/2009	
2	09/04/2009	Split Screen dividers added to exempt list / full Mass Produced Statement added
3	17/06/2013	Link RS1 to note 1

This page intentionally left blank

























## 33 Identification of Controls

**Application:** All Vehicles

Method of Inspection	Required Standard
<p>This inspection is to ensure that any controls, Tell-tales and indicators fitted to the vehicle are; where required readily identifiable and in any case where displayed they would not cause confusion to the driver.</p> <p><b>Identification of certain controls, tell tales and indicators is mandatory and is covered in other relevant sections. This section only applies to optional identification where provided.</b></p> <p>Where a control, tell-tale or indicator is combined, a common symbol may be used for such a combination.</p> <p><b>Note 1:</b> A <b>control</b> means that part of a device which enables the driver to bring about a change in the state or functioning of the vehicle. An <b>indicator</b> means a device which presents information on the functioning or situation of a system or part of a system. e.g., fluid level. <b>A tell-tale</b> means an optical signal which indicates the actuation of a device, correct or defective functioning or condition, or failure to function.</p> <p><b>Note 2:</b> An Information Display Device is a device capable of displaying more than one type of message or information. The requirements regarding colour do not apply to tell-tails and indicators appearing on the Information Display Device.</p> <p><b>Note 3:</b> <b>Tables A and B</b> are for guidance only any method of identification or colours may be used providing this would cause no confusion to the driver.</p>	<p><b>Where provided Identification of Controls, Tell-tales and Indicators;</b></p> <ol style="list-style-type: none"> <li>1. Must be clear so not to cause confusion.</li> <li>2. Must be on or as close to the controls, tell-tales and indicators as possible as not to cause confusion.</li> <li>3. Must stand out clearly from the background.</li> </ol> <p><b>An Information Display Device if Fitted;</b></p> <ol style="list-style-type: none"> <li>4. Must be able to display simultaneously the warning symbols for Brake, Main beam and Direction Indicator where this function is not provided elsewhere.</li> <li>5. Must provide the relevant information regarding tell – tales and indicators whenever the situation that causes them to operate arises.</li> <li>6. Must repeat automatically in sequence or indicate in such a manner that it is visible to and identifiable to the driver when two or more messages are given.</li> </ol>











## Identification of Controls 33

Table A

Control, Tell-tale or Indicator	Symbol	Colour of light / tell - tale	Control, Tell-tale or Indicator	Symbol	Colour of light / tell - tale	Control, Tell-tale or Indicator	Symbol	Colour of light / tell - tale
Master Light		Green	Direction Indicators Or Hazard Warning if both flash together		Green	Ventilating fan		
Dipped Beam Headlamps		Green	Hazard Warning		Red	Diesel Pre-heat		Yellow
Main Beam Headlamps		Blue	Windscreen Wiper		Contrast with background	Choke (cold starting device)		Yellow
Position (side) Lamps		Green	Windscreen Washer		Contrast with background	Brake Failure		Red
Front Fog lamps		Green	Windscreen Wiper and Washer		Contrast with background	Fuel Level		Yellow
Rear Fog Lamps		Yellow	Headlamp Cleaning Device (with separate operating control)		Contrast with background	Battery Charging Condition		Red
Headlamp Levelling device			Windscreen demisting and defrosting (when separate)		Yellow	Engine Coolant temperature		Red
Parking Lamps		Green	Rear Window demisting and defrosting (when separate)		Yellow			

## Identification of Controls 33

**Table B**

Control, Tell-tale or Indicator	Symbol	Notes	Colour of light / tell - tale	Control, Tell-tale or Indicator	Symbol	Colour of light / tell - tale
Parking Brake		Where a single tell-tale indicates more than one brake system condition, except brake anti-lock system failure, the symbol for brake failure must be used.		Horn		
Bonnet		Outline only may be used.		Rear Window Wiper		
Boot		Outline only may be used.		Rear window Washer.		
Seat Belt		Outline only may be used.	Red	Rear Window Wiper and washer.		
Engine Oil Pressure			Red	Intermittent Windscreen wiper.		
Unleaded Petrol						

## Identification of Controls 33

## Record of Revision

Revision	Date	Description of Change
1	27/03/2009	
2	24/05/2010	Amended table A to incorporate TSE IVA 000M1 33 001

## Identification of Controls 33

## 34 Defrost / Demist

**Application:** All Vehicles fitted with a Windscreen (See section 32)

Method of Inspection	Required Standard
<p>Ensure that the vehicle is fitted with a system/systems capable of defrosting and demisting the windscreen to allow the driver an adequate view of the road in front and forward of the nearside and offside of the vehicle</p> <p><b>In the case of unmodified Mass Produced vehicles the standards in this section shall be considered to be met.</b></p> <p><b>Where evidence suggests that the vehicle has been modified, the examiner shall assess whether the modification would be likely to materially affect the performance of the relevant component or system, and if so, carry out assessment against the RS</b></p> <p><b>Note:</b> The fitting of a device not permanently incorporated into the vehicle structure i.e. adhered to the windscreen or body surface shall not be considered as a “system fitted to the vehicle.”</p>	<ol style="list-style-type: none"> <li>1. The vehicle must be fitted with a system capable of defrosting / demisting the windscreen.</li> <li>2. A system using warm air to clear the screen must employ fan assistance and ducting to direct the air onto the screen, to ensure effective operation under cold weather conditions.</li> <li>3. An electrically heated screen must provide adequate heat and distribution to ensure effective operation.</li> </ol>

## Record of Revision

Revision	Date	Description of Change
1	27/03/2009	

## 35 Wash Wipe

**Application:** All Vehicles fitted with a Windscreen (See section 32)

Method of Inspection	Required Standard
<p>Vehicles shall be fitted with adequate windscreen washing and wiping devices. Ensure that all wipers continue to move automatically over an area of the windscreen sufficient to give the driver an adequate view of the road in front and forward of the nearside and offside of the vehicle.</p> <p><b>In the case of unmodified Mass Produced vehicles the standards in this section shall be considered to be met.</b></p> <p><b>Where evidence suggests that the vehicle has been modified, the examiner shall assess whether the modification would be likely to materially affect the performance of the relevant component or system, and if so, carry out assessment against the RS</b></p> <p>The engine should be running and the windscreen must be kept wet when checking the wiper operating cycle frequencies.</p> <p><b>Note 1:</b> This requirement does not apply where a wiper system is designed to operate an Intermittent or delay wipe frequency but this must be in addition to those required by RS 3.</p> <p><b>Note 2:</b> A “cycle” is the forward and return movement of the windscreen wiper.</p>	<ol style="list-style-type: none"> <li>1. The vehicle must be fitted with a windscreen washer and wiper system sufficient to give the driver an adequate view of the road.</li> <li>2. All front wipers must continue to move automatically over the swept area of the windscreen (see <b>Note 1</b>)</li> <li>3. All front wipers must have at least two sweep frequencies one of which must be of at least 45 cycles/min. (see <b>Note 2</b>)</li> <li>4. Additional Sweep frequencies must be of not less than 10 and not more than 55 cycles/minute (see <b>Note 1</b>)</li> <li>5. The difference between the highest and at least one of the lower sweep frequencies must be at least 15 cycles/minute (see <b>Note 2</b>)</li> <li>6. All front wipers must return automatically to a position of rest which is at or beyond the outer edge of the swept area</li> <li>7. All front wipers must be capable of being lifted from the windscreen to allow for cleaning of the windscreen.</li> <li>8. The windscreen washer system must provide enough liquid to adequately clear the windscreen in conjunction with the wipers</li> <li>9. The windscreen washer system must have a reservoir capacity of at least 1 litre</li> <li>10. The windscreen washer system must be able to withstand the load applied when the nozzles are blocked and the system is operated for 3 – 5 seconds</li> </ol>

## Wash Wipe 35

## Record of Revision

Revision	Date	Description of Change
1	27/03/2009	



## 36 Heating Systems

**Application:** All Vehicles (optional fitment)

Method of Inspection	Required Standard
<p><b>In the case of unmodified Mass Produced vehicles the standards in this section shall be considered to be met.</b></p> <p><b>Where evidence suggests that the vehicle has been modified, the examiner shall assess whether the modification would be likely to materially affect the performance of the relevant component or system, and if so, carry out assessment against the RS</b></p> <p><b>Note 1:</b> The air intake must not be positioned near the vehicles exhaust outlet or draw air from within an engine compartment etc. Holes to allow water to drain out of heater intake system into the engine compartment are permitted provided that the total surface of holes amount to less than 1% surface area of the heater intake aperture.</p> <p><b>A combustion heater</b></p> <p>Requires documentary evidence or an 'E' or 'e' marked component and an installation check</p> <p>Ensure that any heater system fitted is safe for use and is not dangerous.</p> <p><b>Note 2:</b> Example message "For gas fuelled systems the heating system must not be used and the gas cylinder valve must be closed when the vehicle is in motion"</p>	<p><b>Heating Systems</b></p> <ol style="list-style-type: none"> <li>1. Must present no obvious fire risk (e.g. flammable parts of the vehicle near to a source of heat or a likelihood of users placing objects liable to catch fire on a very hot surface).</li> <li>2. Must present no obvious injury risk (e.g. likelihood of users touching a very hot surface or hot water pipes).</li> <li>3. Must have air intakes positioned so that there is no likelihood of polluted air being able to enter the passenger compartment, this does not include pollution from external sources. (see <b>Note 1</b>)</li> </ol> <p><b>Combustion Heater</b></p> <ol style="list-style-type: none"> <li>4. The vehicle must be accompanied by satisfactory evidence of compliance with the required standard for "Heating Systems".</li> </ol> <p><b>Installation Check</b></p> <ol style="list-style-type: none"> <li>5. A liquid fuelled or gaseous fuelled combustion heater must be fitted in accordance with the manufacturer's instructions.</li> <li>6. There must be no likelihood of polluted air entering the accommodation / exhibition compartment.</li> <li>7. There must be no obvious fire risk associated with the heating system</li> <li>8. It must be positioned so that it is not likely to cause injury</li> <li>9. It must be positioned so exhaust gases are not likely to enter the accommodation / exhibition compartment</li> </ol>

## Heating Systems 36

Method of Inspection	Required Standard
	<p data-bbox="1196 217 2069 279"><b>LPG heating systems for stationary use only in motor vehicles and their trailers</b></p> <p data-bbox="1196 301 2101 400">The LPG-combustion heater and its supply system of an LPG heating system that is intended to be used only when the vehicle is not in motion, shall comply with the following requirements:</p> <p data-bbox="1196 421 2119 619"><b>10.</b> Permanent labels shall be attached on the compartment where the portable LPG cylinders are stored and in close proximity to the control device for the heating system, giving instructions that the LPG heater shall not be in operation and that the valve of the portable LPG cylinder shall be closed when the vehicle is in motion. (see <b>Note 2</b>)</p>

## Record of Revision

Revision	Date	Description of Change
1	27/03/2009	
2	18/10/2010	Note 1 amended to allow small water drain holes in heater intake system.
3	29/04/2012	Inserted inspection requirements for combustion heaters
4	30/09/2012	Amend text in Mol, Insert new note, new header in RS column and replace RS9
5	03/10/2016	Renumber RS, update RS10, update Note 2.

This page intentionally left blank

## 37 Wheel Guards

**Application:** Vehicles subject to Basic requirements

Method of Inspection	Required Standard
<p>This inspection is to ensure that all vehicles are fitted with adequate wheel guards (parts of the bodywork, mudguards, etc) to protect other road users as far as possible, against thrown up stones, mud, ice, snow and water and to reduce for those users the dangers due to contact with the moving wheels</p> <p><b>In the case of unmodified M1 Mass Produced vehicles the standards in this section shall be considered to be met.</b></p> <p><b>In the case of unmodified mass produced vehicles from categories other than M1 the vehicle must meet the full requirements of this section.</b></p> <p><b>Where evidence suggests that the vehicle has been modified, the examiner shall assess whether the modification would be likely to materially affect the performance of the relevant component or system, and if so, carry out assessment against the RS</b></p> <p>Using a suitable measuring device ensure that the wheel guards cover an adequate area of the wheel/tyre as defined</p> <p><b>Note 1:</b> The rear part of the mudguard after the required 50° to where it terminates does not have to cover the full breadth of the tyre</p> <p><b>Note 2:</b> When determining the wheel guard coverage you must view the tyre from the vertical, horizontal and longitudinal planes</p>	<ol style="list-style-type: none"> <li>1. The vehicle must be fitted with wheel guards</li> <li>2. The wheel guard must extend at least 30 degrees from the centre of the wheel to the front (<b>Figure 1</b>)</li> <li>3. The wheel guard must extend at least 50 degrees from the centre of the wheel to the rear (<b>Figure 1</b>)</li> <li>4. The wheel guard must cover the full breadth of the tyre throughout the required dimensions (see <b>Note 2</b> and <b>Figure 1</b>)</li> <li>5. The rear of the wheel guard must not terminate above a horizontal plane of 150mm above the wheel centre. (see <b>Note1</b> and <b>Figure 1</b>)</li> </ol>

## Wheel Guards 37

Figure 1

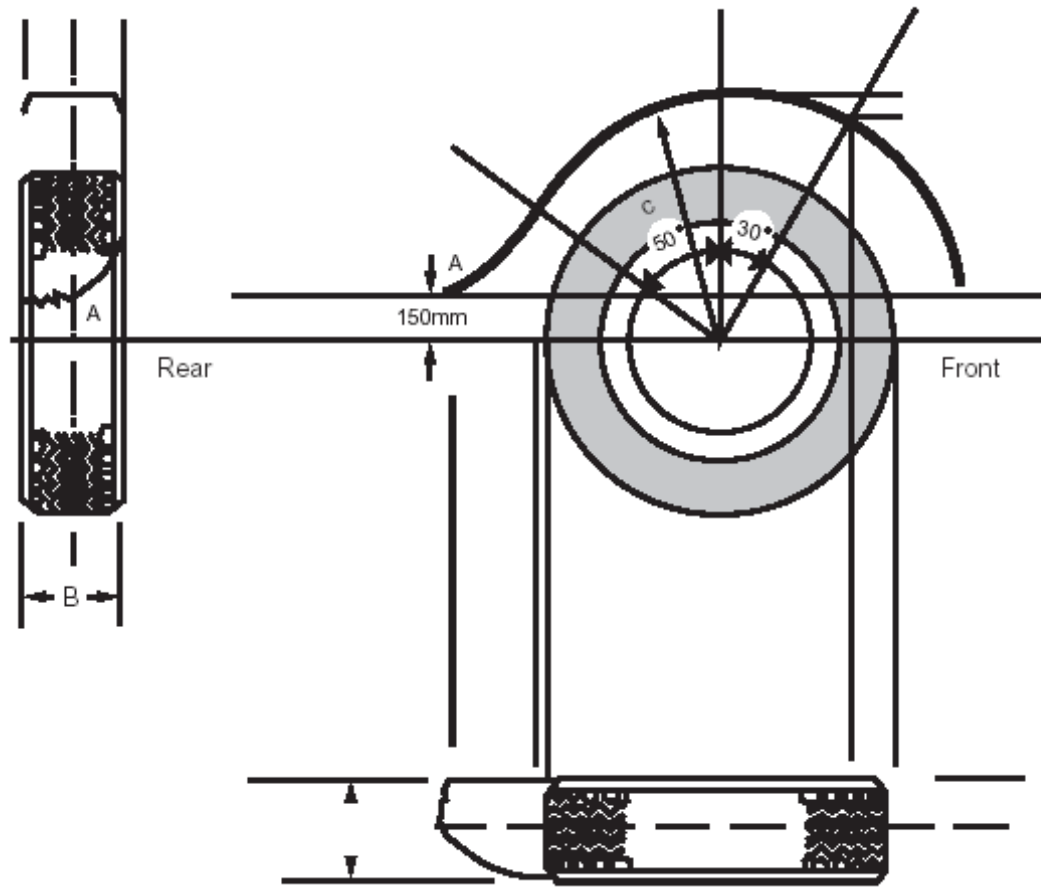

**Record of Revision**

<b>Revision</b>	<b>Date</b>	<b>Description of Change</b>
1	27/03/2009	
2	09/04/2009	Mass Produced Vehicle statement added
3	30/09/2012	Reword Mol paragraph 2 and insert new paragraph 3
4	17/06/2013	Amend wording in Mol paragraph 3

This page intentionally left blank



## 44 Masses and Dimensions

**Application:** All Vehicles

Method of Inspection	Required Standard
<p>All vehicles must not exceed the maximum permitted authorised dimensions.</p> <p><b>In the case of unmodified Mass Produced vehicles RS 3- 9 shall be considered to be met.</b></p> <p>Ideally the vehicle should be accompanied with declared maximum permissible weights and relative evidence, however other than in the case of the maximum permissible towing mass (which must be provided if the vehicle is equipped to tow) where they are not available the weights determined by this section will be utilised for other sections such as 09 Braking and 46 Tyres.</p> <p>Where maximum weights have been provided, check the evidence to ensure that the weights were allocated by the vehicle manufacturer, on mass produced vehicles this may take the form of a VIN plate (see Section 18).</p> <p><b>Note 1:</b> For <b>Motor-caravans</b> the maximum width is 2.6 metres.</p> <p><b>Note 2:</b> Where a mass produced vehicle has been modified, or an axle has been used during the build of a new vehicle and the vehicle/axle weight appears to be heavier than the original vehicle/axle weight then evidence that the modifications justify the increased weights must be provided. This applies for example in the case of a stretched limousine.</p>	<ol style="list-style-type: none"> <li>1. The vehicle must not exceed the maximum length of 12 metres. (see <b>Annex 1</b>)</li> <li>2. The vehicle must not exceed the maximum width of 2.5 metres (see <b>Annex 1</b> and <b>Note 1</b>)</li> <li>3. Where declared the vehicle must be accompanied by satisfactory evidence of the maximum design weights, which have been assigned to the vehicle by the manufacturer.</li> <li>4. The sum of the design axle weights must be equal to or greater than the maximum gross vehicle weight.</li> <li>5. The maximum design gross weight must be equal to or greater than the calculated weights.</li> <li>6. The maximum design front axle weight must be equal to or greater than the calculated weight.</li> <li>7. The maximum design rear axle weight must be equal to or greater than the calculated weight.</li> <li>8. When a vehicle is loaded to its maximum permitted gross weight and its rear axle is loaded to its maximum permitted weight, the front axle weight must not be less than 30% of the maximum gross vehicle weight.</li> <li>9. Where an original axle design weight appears to have been exceeded evidence to increase the weights must be provided (see <b>Note 2</b>)</li> </ol>

## Masses and Dimensions 44

Method of Inspection	Required Standard
<p><b>Axle weight Calculations</b></p> <p><b>a.</b> Obtain the “kerbside weight” of each axle using the provided equipment</p> <p>The “kerbside weight” is the weight of the vehicle as presented, with no driver or passengers, <b>a full fuel tank</b>, an adequate supply of the necessary oils, water, fluids etc and no load other than tools and equipment normally carried.</p> <p><b>Note:</b> For mass produced vehicles / base vehicles, where the original manufacturer’s fuel system / tank are retained and design weight requirements have been declared, full fuel tanks are not required. For these vehicles the missing fuel volume should be ascertained and added to the presented weight.</p> <p>1 Litre petrol = 0.74kg 1 Litre diesel = 0.84kg</p> <p><b>b.</b> Using the “kerbside weight” and the appropriate passenger / luggage weight, calculate (see Annex 2)</p> <ul style="list-style-type: none"> <li>• the maximum permitted weight of each axle</li> <li>• the maximum gross vehicle weight.</li> </ul> <p>The passenger / luggage weight to be used in the calculation is 68kg in each seat (including the driver’s seat) designated for use while the vehicle is travelling on the road, plus 7kg x the number of designated seats, the weight being distributed evenly in the luggage areas.</p> <p>For motor-caravans additional loads must be calculated:</p> <ul style="list-style-type: none"> <li>• 10kg x the number of designated seats</li> <li>• 10kg per metre in length</li> <li>• loads representing 90% full fresh water and gas tanks</li> </ul> <p>For wheelchair accessible vehicles the person and wheelchair weight is assumed to be 100kg</p> <p><b>Note:</b> ambulances must be presented with a stretcher of the type to be carried under normal operating conditions.</p>	<p><b>10.</b> A vehicle which is capable of towing must have a technically permissible towing mass which conforms with the information below</p> <p>Where a vehicle is capable of towing a trailer fitted with a <b>service braking system</b>, the technically permissible maximum towable mass of the vehicle must not exceed either of:</p> <ul style="list-style-type: none"> <li>• the technically permissible mass of the towing vehicle, (OR, for off- road vehicles 1.5 times that mass (See <b>Note 3</b>))</li> <li>• 3500Kg</li> </ul> <p>Where a vehicle is only capable of towing a trailer which is not fitted with a <b>service braking system</b>, then the technically permissible towable mass of the vehicle must not exceed either of;</p> <ul style="list-style-type: none"> <li>• half of the mass of the towing vehicle in running order,</li> <li>• 750kg</li> </ul>

## Masses and Dimensions 44

**Note 3: Definition of an “Off-Road Vehicle” as applied to an M1: (in 70/156EEC)**

A vehicle of category M1 would be considered to be an Off-Road vehicle if they have:

- at least one front axle and at least one rear axle designed to be driven simultaneously including vehicles where the drive to one axle can be disengaged,

or

- at least one differential locking mechanism or at least one mechanism having a similar effect and if they can climb a 30 % gradient calculated for a solo vehicle.

**In addition**, they must satisfy at least five (5) of the following six (6) requirements:

- the approach angle must be at least 25°
- the departure angle must be at least 20°
- the ramp angle must be at least 20°
- the ground clearance under the front axle must be at least 180mm,
- the ground clearance under the rear axle must be at least 180mm
- the ground clearance between the axles must be at least 200mm

Evidence either from a manufacturer or a test lab would need to be supplied to substantiate this.

**Annex1: Items to be excluded from measurement of length and width.**

A - Items to be excluded when measuring Length	B - Items to be excluded when measuring Width
<ul style="list-style-type: none"> <li>• wiper and washer devices,</li> <li>• front or rear registration plates,</li> <li>• lighting equipment,</li> <li>• mirrors and other devices for indirect vision,</li> <li>• access steps, access ladders and hand-holds,</li> <li>• lifting platforms, access ramps and similar equipment in <i>running order</i> (i.e. in the position they would be on a moving vehicle), not exceeding 300 mm, provided that the</li> <li>• loading capacity of the vehicle is not increased,</li> <li>• temporary bike rack,</li> <li>• carrier for mobility scooter,</li> <li>• coupling devices,</li> <li>• trolley booms of electrically-propelled vehicles,</li> <li>• external sun visors,</li> <li>• exhaust pipes.</li> </ul>	<ul style="list-style-type: none"> <li>• tyre-pressure or tyre failure indicators,</li> <li>• protruding flexible parts of wheel guards</li> <li>• lighting equipment,</li> <li>• mirrors and other devices for indirect vision,</li> <li>• access ramps in <i>running order</i> (i.e. in the position they would be on a moving vehicle), provided that they do not exceed 10 mm from the side of the vehicle,</li> <li>• retractable steps,</li> <li>• the deflected part of the tyre walls immediately above the point of contact with the ground,</li> <li>• grab handles for aiding access,</li> <li>• handles and hinges of external lockers,</li> <li>• trim or sealing strips provided they do not exceed 10mm from the side of the vehicle,</li> <li>• exhaust pipes,</li> <li>• on motorhomes: "slide-out" sections,</li> <li>• on motorhomes: awnings (including their support arms), provided that any part more than 1m from the ground does not exceed 50mm, and any part more than 2m from the ground does not exceed 100mm, from the side of the vehicle. Where an awning is attached to a slide out section the measurements are to be taken from the attachment point.</li> </ul>

## Annex 2: Calculation of Maximum Permitted Axle Weight and Maximum Gross Weight

### EXAMPLE 1 Passenger car: All dimensions in metres

This example assumes

- The kerb weight of Axle 1 = 650Kg  
Axle 2 = 400kg
- Each row of seats consists of 2 seats.
- The passenger/driver weight of 75kg per seat distributed
  - 68kg in each seated position (total 272kg)
  - 7kg in the luggage compartment (total 28kg)

Using the vehicle foremost point as a datum, taking moments on Axle 1.

$$\begin{aligned}
 & ((2-1) \times (68 \times 2)) + ((3-1) \times (68 \times 2)) + ((4.5-1) \times 28) \\
 &= (1 \times 136) + (2 \times 136) + (3.5 \times 28) \\
 &= 136 + 272 + 98 \\
 &= \frac{506}{2.7} = 187.4 \text{kg} = \text{additional load on rear axle}
 \end{aligned}$$

Maximum rear axle weight = 187.4kg + kerb weight (400kg) = 587.4kg

Gross weight = kerb weight (1050kg) + passenger weight (300kg) = 1350kg

Max front axle weight = gross weight (1350kg) – rear axle weight (587.4kg) = 762.6kg

#### NOTE: Seat dimensions must be taken

- in the case of an adjustable seat
  - with the seat in the rearmost position
  - to a point 250mm forward of the base of the backrest.
- in any case to a point 200mm forward of the base of the backrest
- Where the vehicle has the facility to tow, the above calculation must be done to also include an additional moment from the datum point to the centre of the tow ball using a weight of 100Kg (unless evidence suggests otherwise).  
(The towing device must be fitted so that the weight of it is included when weighing the front and rear axles).

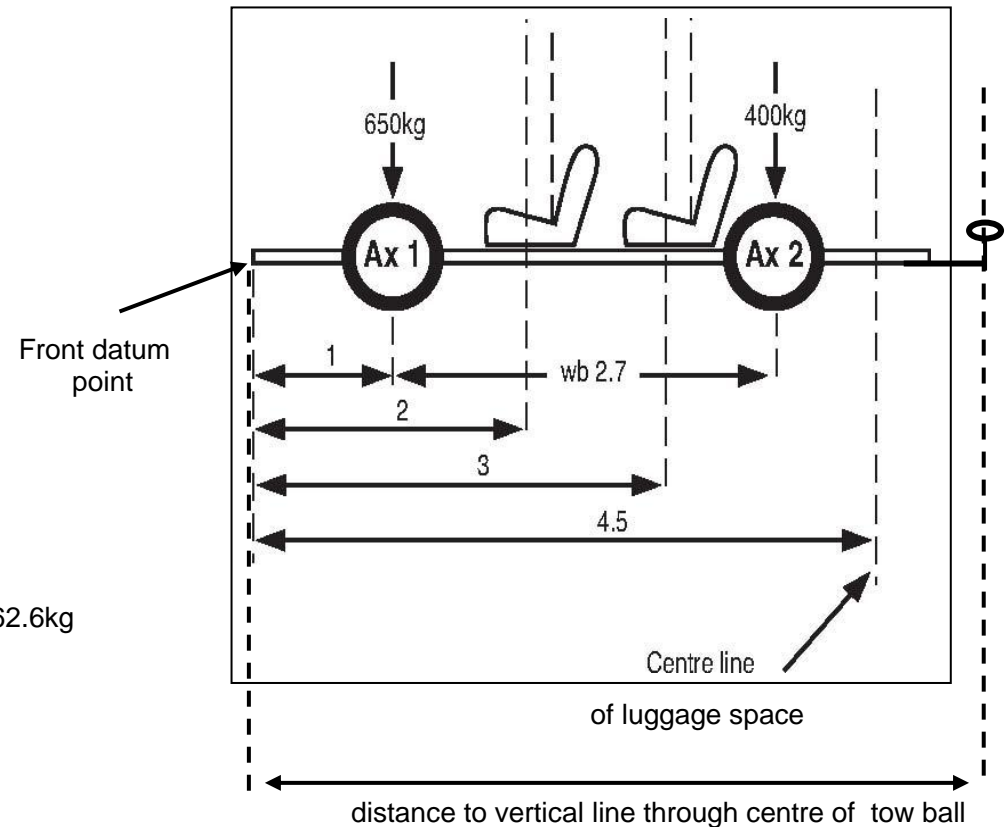

## Masses and Dimensions 44

**Example 2 Motor Caravan:** Additional loads**Motor caravan with a kerbside weight of 6900kg**

When measured the motor-caravan is 10.25 metres in length

The vehicle is fitted with

- 260 l Water tank - weight when 90% Full - 234kgs (1 litre water = 1kg)
- 40kg Gas tank - weight when 90% Full - 36kgs

The vehicle has 5 seating positions that have been designated for use while the vehicle is travelling on the road.

The passenger/driver weight of 75kg per seat distributed

- 68kg in each seated position (total 340kg)
- 7kg in the luggage compartment (total 35kg)

Additional 10kg per seating position **located as specified by applicant**

- 10kg per passenger (total 50kg)

Additional 10kg per metre in length located as specified by applicant

- 10kg per metre (100kg)

Moments are taken in similar manner to other vehicle types to calculate individual axle loads

- +375kg** - Normal M1 vehicle passenger and luggage allowance
- +234 kg** - Water tank 90% full
- +36 kg** - Gas tank 90% full
- +50kg** - Additional luggage per passenger
- +100kg** - Additional load based on vehicle length

So this vehicle will require a minimum gross vehicle weight of **7695 kg** as it is a motor-caravan

**Masses and Dimensions 44**

## Record of Revision

Revision	Date	Description of Change
1	27/03/2009	
2	09/04/2009	Exemption to RS3 – 9 added for Mass Produced Vehicles
3	24/05/2010	Added wheelchair and occupant weight to be used in calculations to align with RVAR 2009
4	28/02/2011	Added motor-caravan requirements to comply with directive requirements
5	31/07/2011	Changed the dimension in Note 1 from mm to metres
6	30/09/2012	Reword Mol paragraph b, page 2
7	17/06/2013	Remove numbering from notes 3 & 4, link RS10 to note 3, insert text in example 2 on page 6
8	03/10/2016	Mol Axle weight calculations note expanded, Annex 1 B exemptions clarified

This page intentionally left blank



# 45 Safety Glass

**Application:** All Vehicles

Method of Inspection	Required Standard
<p>Check that all windscreens, windows, and side screens are securely attached to the vehicle and are constructed from approved materials.</p> <p>Clear panels fitted to the vehicle that do not impinge on the forward, rearward or sideward view of the driver are considered to be body panels and are not subject to the requirements of this section.</p> <p>Armoured vehicles do not have to display approval markings.</p> <p><b>Note 1:</b> For definition of windscreen see section 32</p> <p><b>Note 2:</b> “Safety Glazing” made from glass must be so constructed or treated that if fractured it does not fly into fragments likely to cause severe cuts. Each piece of glass must display the following relevant permanent marking applied by the glass manufacturer. ECE Regulation 43</p> <div style="text-align: center; margin: 10px 0;">  </div> <p><b>Note 3:</b> “Safety Glazing” made from plastic means material which is so constructed or treated that if fractured it does not fly into fragments likely to cause severe cuts. “Safety glazing” made from plastic must have an “e” mark applied by the material manufacturer.</p> <p><b>Note 4:</b> The rear glazing in the folding roof of a convertible vehicle may be made of a flexible plastic pane.</p>	<ol style="list-style-type: none"> <li>1. Windscreens, windows and side-screens where fitted must be securely attached to the vehicle.</li> <li>2. Windscreens, windows, internal glazed panels and side-screens where fitted must be suitable for its use. (see <b>Note 1</b> and <b>Table 1</b>)</li> <li>3. Windscreens must be “Safety Glazing” made from glass and display the relevant markings. (see <b>Note 2</b> and <b>Table 1</b>)</li> <li>4. All other windows (including sunroofs and removable glass panels) and side-screens must be “Safety Glazing” (which may be made from glass, or from plastic) and display the relevant markings. (see <b>Notes 2, 3, 4</b> and <b>Table 1</b>)</li> <li>5. Windscreens and windows wholly or partly on either side of the driver’s seat must allow a visual transmission of at least 70%, or 60% in the case of an armoured vehicle. (see <b>Note 5</b>)</li> <li>6. Driver’s forward vision must not be distorted by the glazing material</li> <li>7. Window(s) missing (see <b>Note 6</b>)</li> </ol>

Method of Inspection	Required Standard
<p><b>Note 5:</b> A greater opacity is permitted in the area of the windscreen below the “windscreen horizontal plane” and the area considered to be above the normal field of view.</p> <p><b>Note 6:</b> The fitting of window ‘glass’ is not mandatory but where fitted it must be assessed according to the required standards and if it is obvious the window has been deliberately removed for the purpose of the test then the window can be considered missing.</p> <p>To confirm that the window has been deliberately removed an examiner should ensure that there are no window mechanisms, runners etc. or other window fixings that would indicate that a window should be fitted. If it is clear that, without modification, a window can be fitted then the window is to be considered missing.</p>	

Table 1

Type of window	Relevant Markings (Mandatory) In addition to “E” approval	Supplementary Markings	Markings Not Allowed
Windscreen	<b>I</b> -for toughened glass <b>II</b> -for ordinary laminated glass <b>III</b> -for treated laminated glass <b>IV</b> -for glass-plastics glazing.		<b>V</b> - safety glazing having a regular light transmittance less than 70 per cent. <b>VI</b> - double-glazed unit <b>VII</b> - uniformly-toughened glass which can <b>only</b> be used as windscreens for slow-moving vehicles which, by construction, cannot exceed 40 km/h. <b>VIII</b> -In the case of rigid plastic glazing.
Windows wholly or partly on either side of the driver’s seat	<b>VII</b> - uniformly-toughened glass which can <b>only</b> be used as windscreens for slow-moving vehicles which, by construction, cannot exceed 40 km/h. <b>VIII</b> -In the case of rigid plastic glazing. In addition the appropriate application will be signified by: <b>/B</b> or <b>/C</b> Where plastic glazing has been submitted	<b>VIII/B</b> for side, rear and roof glazing <b>VIII/C</b> in locations where there is little or no chance of head impact. <b>/L</b> will be added to one of the above where the glazing is requisite for the driver’s forward field of vision.	<b>V</b> -in the case of safety glazing having a regular light transmittance less than 70 per cent.

	for abrasion resistance tests the following markings will also be applied: <b>/L</b> or <b>/M</b>		
Other windows and other glazed panels including internal glazed partitions.	<p><b>VII</b> - uniformly-toughened glass which can <b>only</b> be used as windscreens for slow-moving vehicles which, by construction, cannot exceed 40 km/h.</p> <p><b>VIII</b> -In the case of rigid plastic glazing. In addition the appropriate application will be signified by: <b>/A</b>, <b>/B</b> or <b>/C</b></p> <p>Where plastic glazing has been submitted for abrasion resistance tests the following markings will also be applied: <b>/L</b> or <b>/M</b></p>	<p><b>VIII/A</b> for forward facing panes</p> <p><b>VIII/B</b> for side, rear and roof glazing</p> <p><b>VIII/C</b> in locations where there is little or no chance of head impact.</p> <p><b>/L</b> will be added to one of the above where the glazing is requisite for the driver's forward field of vision.</p> <p><b>/M</b> will be added to one of the above where the glazing is requisite for the driver's rearward field of vision.</p>	

These symbols may be marked down in a different format i.e. **II - IV**

#### **Laminated-glass**

Means glazing consisting of two or more layers of glass held together by one or more interlayers of plastics material; it may be:

"**ordinary**", when none of the layers of glass of which it is composed has been treated; **or**

"**treated**", when at least one of the layers of glass of which it is composed has been specially treated to increase its mechanical strength and to condition its fragmentation after shattering;

#### **Glass-plastics glazing**

Means glazing consisting of any glazing material that comprises one layer of glass and one or more layers of plastic in which a plastic surface of the product faces the inner side.

#### **Rigid plastic glazing**

Means a plastic glazing material which does not deflect vertically more than 50 mm in the flexibility test

#### **Glazing requisite for the driver's forward field of vision**

Means all the glazing situated in front of a plane passing through the driver's seat reference 'R' point (see figure Section 31) perpendicular to the longitudinal centre line of the vehicle through which the driver can view the road when driving or manoeuvring the vehicle.

#### **Glazing requisite for the driver's rearward field of vision**

Means all the glazing situated behind a plane passing through the driver's seat reference 'R' point perpendicular to the longitudinal centre line of the vehicle through which the driver can view the road when driving or manoeuvring the vehicle.

## Record of Revision

Revision	Date	Description of Change
1	27/03/2009	
2	09/04/2009	Plastic glazing now allowed for windows wholly or partly to the side of the driver's seat / marking and definitions added to Table 1
3	24/05/2010	Amended MOI following discussion with VCA as to whether clear body panels would require E marking. Added RS6 to align with RVAR 2009
4	31/10/2011	Add approval markings exemption for Armoured Vehicles (new paragraph 3)
5	29/04/2012	Insert procedure for missing window(s) and rear window in convertible hood
6	17/06/2013	Reformat section & update Table 1.
7	03/10/2016	Update table 1, update definitions.

This page intentionally left blank

## 46 Tyres

**Application:** All Vehicles (All Tyres)

Method of Inspection	Required Standard
<p>In the case of <b>Armoured</b> vehicles exemption from any requirement of this section is permitted if it can be demonstrated to the satisfaction of the Approval Authority that it is impossible for the vehicle to comply due to its special purpose.</p> <p><b>Note 1:</b> It is acceptable that tyres displaying a 'VR' or 'ZR' rating do not display an 'E' or 'e' marking.</p> <p><b>Note 2:</b> Where the level of performance or safety provided is in question, the vehicle presenter must provide documentary evidence to demonstrate that the tyre would meet requirements equivalent to those of an 'E' or 'e' marked tyre.</p> <p><b>Note 3:</b> A four-wheeled vehicle fitted with single wheels must not have:</p> <ul style="list-style-type: none"> <li>• a crossply tyre or bias belted tyre fitted on the rear axle and a radial tyre fitted on the front axle</li> <li>• a crossply tyre fitted on the rear axle and a bias belted tyre fitted on the front axle.</li> </ul> <p>Any tyre structure mix <b>between different axles</b> is acceptable for vehicles that have:</p> <ul style="list-style-type: none"> <li>• two axles and 'twin' wheels on the rear axle</li> <li>• three axles, one steering and one driving</li> </ul> <p><b>Note 4:</b> Evidence of, or a written declaration of, the maximum design speed of the vehicle should be produced by the vehicle manufacturer/owner.</p>	<ol style="list-style-type: none"> <li>1. Each tyre must bear an 'E' or 'e', DOT or JIS approval mark (see <b>Notes 1 and 2</b>)</li> <li>2. Each tyre must be manufactured so that it displays permanently the following service information:             <ol style="list-style-type: none"> <li>a. nominal size</li> <li>b. construction type (e.g. radial, cross ply or bias belt)</li> </ol> </li> <li>3. Each tyre must be manufactured so that it displays permanently the following service information markings (see note in Annex 1):             <ol style="list-style-type: none"> <li>a. load capacity</li> <li>b. speed capability, or</li> <li>c. is accompanied by documentation that provides this information.</li> </ol> </li> <li>4. All tyres on the same axle must have the same structure (e.g. bias-belted, crossply or radial)             <ol style="list-style-type: none"> <li>a. nominal size</li> <li>b. aspect ratio</li> </ol> </li> <li>5. Tyres must be of the correct structure, taking account of their position on the vehicle and the vehicle axle configuration. (see <b>Note 3</b>)</li> <li>6. Each tyre must be of the correct nominal size for the wheel to which it is fitted.</li> <li>7. Each tyre must have the adequate speed capability (speed rating)</li> </ol>

Method of Inspection	Required Standard
<p><b>Note 5:</b> Tyre tread depths are only required to be checked (using the digital tyre depth gauge) when it is visually obvious that there is a concern with that tyre.</p> <p><b>Note 6: Temporary-use spare</b> this speed warning symbol / reference is only required for wheel and tyre combinations.</p>	<p>for the maximum design speed of the vehicle (see <b>Note 4</b> and <b>Annex 1</b>).</p> <ol style="list-style-type: none"> <li>8. Each tyre must have the adequate load capacity for the axle to which it is fitted (see Annex 2 and 3) at the manufacturers stated maximum permitted axle weight (as indicated by documentary evidence or manufacturers plate) or where this is not available at the at the calculated maximum permitted axle weight. (for calculated axle weight see section 44). Note where both are available the higher value will be used.</li> <li>9. Tyres must be fitted in accordance with the manufacturer's instructions as indicated on the side wall of the tyre</li> <li>10. The load capacity of the temporary-use spare unit must be at least equal to one half of the highest of the maximum axle loads of the vehicle</li> <li>11. For temporary-use spare a 80 km/h or 50mph maximum speed warning symbol / reference must be permanently displayed on the outer face of the wheel in a prominent position (see <b>Note 6</b>)</li> <li>12. The grooves of the tread pattern must be, at least 1.6mm throughout a continuous band comprising of the centre <math>\frac{3}{4}</math> of the breadth of tread around the outer circumference of the tyre. (see <b>Note 5</b>)</li> </ol>



## Annex 1 Speed Categories

### TABLE 1

For speeds not exceeding 130mph the maximum load rating shall not exceed the value associated with the load capacity index of the tyre

### TABLE 2

For speeds higher than 130mph, but not exceeding 149mph, (tyres classified with speed category symbol “V”) the maximum load rating shall not exceed the percentage of the value associated with the load capacity index of the tyre, indicated in the table below, with reference to the speed capability of the car to which the tyre is fitted.

### TABLE 3

For speeds higher than 149mph, but not exceeding 168mph (tyres classified with speed category symbol “W”) the maximum load rating shall not exceed the percentage of the value associated with the load capacity index of the tyre, indicated in the table below, with reference to the speed capability of the car to which the tyre is fitted.

### TABLE 4

For speeds higher than 168mph, but not exceeding 186mph (tyres classified with speed category symbol “Y”) the maximum load rating shall not exceed the percentage of the value associated with the load capacity index of the tyre, indicated in the table below, with reference to the speed capability of the car to which the tyre is fitted.

**NOTE:** On radial-ply tyres suitable for higher speeds, the letter ‘R’ in the tyre designation (placed in front of the rim diameter) may be replaced by ‘VR’ or ‘ZR’, e.g. 205/55ZR16.

Tyres displaying the “VR” or “ZR” marking may not display a load index or speed rating.

If a tyre load capacity is displayed and is suitable, documentary evidence of the tyre speed capability is only necessary if the vehicle maximum road speed is in excess of 130mph (in the case of a vehicle fitted with a “VR” tyre) or 149mph (in the case of a vehicle fitted with a “ZR” tyre)

If a tyre load capacity is not displayed documentary evidence of its capabilities will be required.

A tyre marked with only with a load capability in lbs/kg is acceptable providing its speed capability is also indicated; otherwise manufacturer’s evidence/information will be required.

**Table 1**

Speed Category Symbol	Corresponding Speed	
	(km/h)	(mph)
L	120	75
M	130	81
N	140	87
P	150	93
Q	160	99
R	170	106
S	180	112
T	190	118
U	200	124
H	210	130
V	240	149 - see Table II
W	270	168 - see Table III
Y	300	186 - see Table IV

**Table 2**

Maximum Speed		Load (%)
(km/h)	(mph)	
215	134	98.5
220	137	97
225	140	95.5
230	143	94
235	146	92.5
240	149	91

**Table 3**

Maximum Speed		Load (%)
(km/h)	(mph)	
240	149	100
250	155	95
260	162	90
270	168	85

**Table 4**

Maximum Speed		Load (%)
(km/h)	(mph)	
270	168	100
280	174	95
290	180	90
300	186	85

**Annex 2 Tyre Capacity Tables (Ply Rated Tyres)**

Tyre Size	Ply Rating	Maximum Axle Loads Kg			Tyre Size	Ply Rating	Maximum Axle Loads Kg	
		Single	Twin				Single	Twin
500-10	6	740	-		205-14	RADIAL	1420	2820
145-12C	6	920	1740		205-14	REINFORCED RADIAL	1650	3160
145-12C	8	1060	2000		205-14C	6	1850	3510
155-12C	6	980	1850		205-14C	8	2060	3900
550-12C	6	850	1600		215-14C	8	2240	4240
600-12C	6	980	1880		590-14C	6	1170	2240
700-12	12	2550	4800		600-14C	8	1260	2400
700-12	14	2750	5090		640-14C	6	1330	2550
145-13C	6	970	1840		650-14	4	970	1860
145-13C	8	1120	2120		650-14C	6	1300	2460
165-13	4	920	-		650-14C	8	1500	2840
175-13	6	1340	2520		670-14C	6	1430	2750
560-13C	6	1020	1940		670-14C	8	1680	3160
590-13C	6	1070	2090		700-14	4	1070	2050
640-13C	6	1280	2240		700-14C	6	1380	2650
640-13C	8	1430	2750		750-14	4	1200	2300
670-13C	6	1380	2650		750-14C	6	1530	2950
670-13C	8	1580	3050		750-14C	8	1730	3360
1050-13	12	4320	7880		11-15	6	2240	-
1050-13	14	4830	8900		145-15C	8	1230	2320
155-14C	6	1070	2040		185-15C	8	1750	3400
165-14C	6	1300	2460		590-15C	6	1220	2340
165-14C	8	1460	2760		640-15C	6	1380	2650
175-14C	6	1430	2680		670-15C	6	1530	2900
175-14C	8	1550	3000		670-15C	8	1780	3460
185-14	RADIAL	1200	2300		670-15	10	2000	3900
185-14	REINFORCED RADIAL	1340	2560		700-15C	6	1750	3400
185-14	4	1340	2560		700-15C	8	1940	3760
185-14C	6	1550	2920		700-15	12	2440	4580
185-14C	8	1700	3200		750-15C	6	1830	3560
195-14	RADIAL	1300	2490		750-15C	8	2060	3970
195-14	REINFORCED RADIAL	1500	2870		750-15	10	2340	4370
195-14C	6	1700	3210		750-15	12	2750	5340
195-14C	8	1900	3600		750-15	14	3150	6100
					750-15	16	3660	6860

Tyre Size	Ply Rating	Maximum Axle Loads Kg			Tyre Size	Ply Rating	Maximum Axle Loads Kg	
		Single	Twin				Single	Twin
825-15	12	3050	5590		700-16	6	1370	3260
825-15	14	3360	6360		700-16	8	2040	3870
825-15	18	4680	8540		700-16	10	2340	4480
825-15	20	5000	9440		700-16	12	2650	5000
1000-15	12	3870	7120		750-16	6	2040	3870
1000-15	14	4320	8130		750-16	8	2240	4270
1000-15	16	5020	9580		750-16	10	2500	4720
1000-15	18	5400	10170		750-16	12	2900	5600
175-16C	6	1500	2840		825-16	8	2650	4880
175-16C	8	1650	3100		825-16	10	2850	5440
185-16C	8	1800	3400		825-16	12	3300	6400
195-16C	8	1950	3700		825-16	14	3600	6800
205-16C	6	1900	3610		900-16	6	2360	4360
205-16C	8	2120	4000		900-16	8	2720	5140
215-16C	6	2120	4000		900-16	10	3050	5600
215-16C	8	2300	4360		900-16	12	4070	7200
235/85-16	10	2760	5040		900-16	14	4320	7800
600-16	6	1380	2550					
600-16	8	1530	2920					
600-16	10	1830	3300					
650-16	6	1530	2920					
650-16	8	1830	3460					
650-16	10	2040	3900					

**Annex 3 Tyre Capacity Tables (Load Index Tyres)**

Load Index	Single Kg	Twin Kg	Load Index	Single Kg	Twin Kg	Load Index	Single Kg	Twin Kg
70	670	1340	107	1950	3900	144	5600	11200
71	690	1380	108	2000	4000	145	5800	11600
72	710	1420	109	2060	4120	146	6000	12000
73	730	1460	110	2120	4240	147	6150	12300
74	750	1500	111	2180	4360	148	6300	12600
75	774	1548	112	2240	4480	149	6500	13000
76	800	1600	113	2300	4600	150	6700	13400
77	824	1648	114	2360	4720	151	6900	13800
78	850	1700	115	2430	4860	152	7100	14200
79	874	1748	116	2500	5000	153	7300	14600
80	900	1800	117	2570	5140	154	7500	15000
81	924	1848	118	2640	5280	155	7750	15500
82	950	1900	119	2720	5440	156	8000	16000
83	974	1948	120	2800	5600	157	8250	16500
84	1000	2000	121	2900	5800	158	8500	17000
85	1030	2060	122	3000	6000	159	8750	17500
86	1060	2120	123	3100	6200	160	9000	18000
87	1090	2180	124	3200	6400	161	9250	18500
88	1120	2240	125	3300	6600	162	9500	19000
89	1160	2320	126	3400	6800	163	9750	19500
90	1200	2400	127	3500	7000	164	10000	20000
91	1230	2460	128	3600	7200	165	10300	20600
92	1260	2520	129	3700	7400	166	10600	21200
93	1300	2600	130	3800	7600	167	10900	21800
94	1340	2680	131	3900	7800	168	11200	22400
95	1380	2760	132	4000	8000	169	11600	23200
96	1420	2840	133	4120	8240	170	12000	24000
97	1460	2920	134	4240	8480	171	12300	24600
98	1500	3000	135	4360	8720	172	12600	25200
99	1550	3100	136	4480	8960	173	13000	26000
101	1600	3200	137	4600	9200	174	13400	26800
101	1650	3300	138	4720	9440	175	13800	27600
102	1700	3400	139	4860	9720	176	14200	28400
103	1750	3500	140	5000	10000	177	14600	29200
104	1800	3600	141	5150	10300	178	15000	30000
105	1850	3700	142	5300	10600	179	15500	31000
106	1900	3800	143	5450	10900			

**Tyres 46**

## Record of Revision

Revision	Date	Description of Change
1	27/03/2009	
2	24/05/2010	Amend wording of RS 11 to clarify 50mph or 80kmh label on temporary spare is acceptable, amended RS 3 to reference note in annex 1 as per TSE IVA 000M1 46 001
3	30/09/2012	Annex 1 – Insert new sentence and reword last sentence
4	17/06/2013	Reformat RS2 and table numbers page 3

# 50 Couplings

**Application:** All Vehicles

Method of Inspection	Required Standard						
<p>This section applies to all devices that have been fitted post vehicle manufacture. Typically comprising a separate frame attached to the vehicle structure.</p> <p>Towing attachments that do not incorporate a 50mm ball are not permitted e.g. Military style hook type fittings and pin types.</p> <p>Check the security of the coupling ball and towing bracket</p> <ul style="list-style-type: none"> <li>• The number and grade of securing bolts required</li> <li>• Whether appropriate reinforcement or load spreader plates are fitted.</li> <li>• The coupling ball must not be mounted so as to obscure the place or visibility of the rear licence plate. If it is mounted in this area, then a coupling ball that can be dismantled without special tools has to be used.</li> </ul> <p>Check installation height of the coupling and that there is sufficient clearance around it to enable safe operation.</p> <p><b>Note 1:</b> Minimum and maximum height requirements not required on off-road vehicles as defined in section 44</p> <table border="1" data-bbox="150 1099 1209 1203"> <thead> <tr> <th data-bbox="150 1099 680 1134">Minimum Height</th> <th data-bbox="680 1099 1209 1134">Maximum Height</th> </tr> </thead> <tbody> <tr> <td data-bbox="150 1134 680 1169">375 mm</td> <td data-bbox="680 1134 1209 1169">500 mm</td> </tr> <tr> <td colspan="2" data-bbox="150 1169 1209 1203">Coupling height requirements measured (vehicle unladen) to the top of the ball</td> </tr> </tbody> </table> <p><b>Note 2:</b> Modular coupling receivers, typically found on vehicles produced in North America are integrated into the construction of the vehicle during manufacture and are therefore outside of the scope of this Section.</p>	Minimum Height	Maximum Height	375 mm	500 mm	Coupling height requirements measured (vehicle unladen) to the top of the ball		<ol style="list-style-type: none"> <li>1. Any towing device fitted must be of the correct type and be fitted with a 50mm diameter tow ball</li> <li>2. The coupling frame must bear an 'e' or 'E' mark to ensure the construction of the device meets the appropriate approval criteria.</li> <li>3. The coupling device(s) must be securely mounted to the vehicle</li> <li>4. The coupling ball and / or towing bracket must be installed to the correct height. (see <b>Note 1</b>)</li> <li>5. If a coupling device is fitted then the vehicle must be provided with a Gross Train Weight, which must satisfy the requirements of Section 44.</li> </ol>
Minimum Height	Maximum Height						
375 mm	500 mm						
Coupling height requirements measured (vehicle unladen) to the top of the ball							

## Record of Revision

Revision	Date	Description of Change
1	27/03/2009	
2	24/05/2010	Maximum height for couplings increased to account for vehicle being assessed unladen, RS 6 removed as it is not requirement of EC directive 94/20. Altered measuring point on coupling to aid repeatability of assessment
3	17/06/2013	Wording changed for coupling height requirements.



## 60 Frontal Protection System (Bull bar)

**Application:** All Vehicles

Method of Inspection	Required Standard
<p>Ensure the vehicle has satisfactory evidence of compliance to the required standard <b>as presented</b>, or has a genuine 'e' mark that was applied at the time of manufacture and is permanently attached.</p> <p>This inspection does not apply to integral bars that form part of the body work providing the requirements of section 16 exterior are met.</p>	<ol style="list-style-type: none"><li>1. The Frontal Protection System must display a genuine permanently attached 'e' mark that would be applied at the time of manufacture</li></ol>

### Record of Revision

Revision	Date	Description of Change
1	27/03/2009	
2	17/06/2013	Remove numbering from note

## 69 Electric/Hybrid Vehicles – For information only

**Application:** All Electric/Hybrid Vehicles

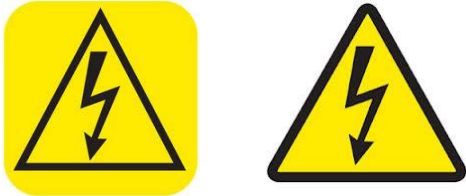
Method of Inspection	Required Standard
<p>This section should be read in conjunction with the required standards set out in General Construction.</p> <p>Ensure the vehicle or system as presented is accompanied by satisfactory evidence in the form of:</p> <p>Original mass produced vehicle approval to ECE R100, or</p> <ul style="list-style-type: none"> <li>• A test report to ECE R100.01 witnessed by the Approval Authority (VCA) or Authorised Technical Service</li> <li>• Model Report created by Technical &amp; Support Services, Ellipse Swansea (TaSS)</li> </ul> <p>and in these cases a Visual Inspection is required</p> <p><b>Note 1:</b> The use of stretchy or soft coverings over high voltage terminals is strictly forbidden.</p> <p>Figure 1</p> <div style="text-align: center;">  </div>	<ol style="list-style-type: none"> <li>1. The vehicle <b>as presented</b> must be accompanied by satisfactory documentary evidence of compliance with the required standard for (electric vehicles)</li> </ol> <p><b>Visual Inspection</b></p> <ol style="list-style-type: none"> <li>2. All high voltage cable terminations must be suitably protected, these protections (solid insulator , barrier, enclosure, etc.) shall not be able to be opened, disassembled or removed without the use of tools (see <b>Note 1</b>)</li> <li>3. Vehicles fitted with an external charging point shall be clearly marked on or near the connection point with an indelible label (see Figure 1) affixed in a visible location.</li> <li>4. Any enclosure carrying high voltage shall be clearly marked with an indelible label (see Figure 1) affixed in a visible location.</li> <li>5. All visible high voltage cables must be orange in colour.</li> <li>6. All metal enclosures with internal high voltage must have an earth path for protection against electrical shock (this may be a separate bonding or the mounting arrangement where it does not isolate the enclosure)</li> </ol>

## Electric/Hybrid Vehicles 69

## Record of Revision

Revision	Date	Description of Change
1	03/10/2016	New Section

# General Construction

**Application:** All Vehicles subject to IVA requirements except new unmodified mass produced vehicles

Method of Inspection	Required Standard
<p>The following section assesses the vehicles suitability for use under all normal operating conditions, including when it is laden to its maximum permitted axle/gross vehicle weight and considers the effects of vibrations and the forces imposed by its design speed, acceleration characteristics, braking and cornering. The vehicle must at all times present no danger to the occupants or other road users.</p> <p><b>Note 1:</b> A television monitor which can be seen from the driving position is only acceptable if it is incapable of showing normal TV DVD when the vehicle is in motion <b>or</b> it only provides visibility to the rear of the vehicle, a navigation map, vehicle specific information or a combination of these items.</p> <p><b>Note 2</b> This assessment includes the attachment of any component/assembly of any structure, the strength and suitability of materials used, (including pipes etc), all fastenings, (welding, brazing, bonding, rivets, nuts and bolts etc) are to be assessed for suitability, completeness and security.</p> <p><b>Note 3</b> When assessing a component for leaks the original design of the component will be taken into consideration.</p> <p><b>Note 4:</b> In the case of Motor Caravans this dimension can be extended to 400mm providing the wiring is held secure.</p>	<ol style="list-style-type: none"> <li>1. <b>All</b> aspects of the design and construction of the vehicle must be such that no immediate danger is caused or likely to be caused to any person in the vehicle or to other road users (see <b>Note 1</b>).</li> <li>2. When driven, the safe control of the vehicle must not be impaired or likely to be impaired, due to a design/construction feature or characteristic.</li> <li>3. The vehicle structure and all components including their attachment must be suitable and of adequate strength. (see <b>Note 2</b>)</li> <li>4. A transmission/braking component which rotates during vehicle operation, electrical component, steering or suspension component, wheel or tyre must not foul on another component, or be likely to foul under normal operating conditions.</li> <li>5. Fuel and electrical components must not be subject to either a corrosive environment or be exposed to heat sources likely to cause premature failure.</li> <li>6. All steering, suspension, brake and fuel system components must not be leaking. (See <b>Note 3</b>)</li> <li>7. All electrical cables/wires must be free from chaffing and secured at intervals of <b>at least</b> every 300mm unless contained in a secure hollow component. (see <b>Note 4</b>)</li> <li>8. All electrical components must be secure be of adequate capacity and insulated as required as to prevent short circuiting during operation.</li> </ol>

## General Construction

## Record of Revision

Revision	Date	Description of Change
1	27/03/2009	
2	30/09/2012	Insert new Note 4 with RS7
3	17/06/2013	Correction to RS2

## Normal IVA Requirements

**Where a vehicle is subject to Normal IVA, all the Basic subjects are tested except those where documentary evidence is required, or has been provided. Where compliance with the Comparable standards is demonstrated, there is no need to test the vehicle in that subject other than to verify the vehicle has not been adapted or modified so that the evidence is in question.**

In relation to the Normal IVA Inspection the examiner must be satisfied that the documentary evidence provided relates to the vehicle in its **presented** condition. Modifications should be judged as to their effect on the documentary evidence or if they have been made in order to ensure compliance.

### Record of Revision

Revision	Date	Description of Change
1	27/03/2009	



# 01 Noise

**Application:** Vehicles subject to Normal requirements

Method of Inspection	Required Standard
<p>Ensure the vehicle <b>as presented</b> is accompanied by satisfactory evidence to the required standard</p> <p><b>Conversions that are not based on M1 vehicles may comply with the applicable requirements of the original base vehicle. Documentary evidence of base or incomplete vehicle approvals will be deemed acceptable.</b></p> <p><b>Note 1:</b> Manufacturers drain holes are permitted in silencers</p> <p><b>Note 2:</b> Where evidence of compliance has been provided, subsequent modification to the exhaust system will be permitted providing</p> <ol style="list-style-type: none"> <li>a. it is downstream of any emissions control device (e.g. catalyst), and</li> <li>b. the emission control device and silencer are identical to that fitted at the time of compliance was demonstrated.</li> </ol> <p><b>Note 3:</b> Different silencers may be fitted downstream of the emissions control device. However, further evidence of compliance will be required for the vehicle in its modified condition. This may be provided in the form of a test report comprising of a stationary comparison test of the vehicle fitted with the original silencer and the alternative silencer.</p> <p>The exhaust may have several outlets up to 300mm apart connected to the same silencer. In this instance the microphone must face the outlet closest to the vehicle contour or highest from the ground. In all other cases, separate measurements must be taken for each exhaust outlet; the highest value obtained is the test value.</p>	<ol style="list-style-type: none"> <li>1. The vehicle <b>as presented</b> must be accompanied by satisfactory evidence of compliance with the required standard for “noise” with No un-permitted modifications to the exhaust system which would invalidate the evidence. (See <b>Notes 2 and 3</b>)</li> <li>2. The exhaust system must be securely mounted.</li> <li>3. Exhaust system components must be secure.</li> <li>4. The exhaust system must be free from leaks. (See <b>Note 1</b>)</li> </ol> <p><b>Where applicable:</b></p> <ol style="list-style-type: none"> <li>5. A vehicle with permitted modifications must be accompanied by a stationary noise test report</li> <li>6. The measured sound level must be no more than 2 dBA above the evidence supplied.</li> </ol>

Method of Inspection	Required Standard
<p>Where a different silencer is fitted to a <b>Wheel Chair Accessible Vehicle</b>, it may be noise tested directly against the evidence provided, if the evidence contains a static noise value.</p> <p>The noise emitted from the exhaust system will be measured if:</p> <ul style="list-style-type: none"> <li>a. the model report is a “version 1” report <b>or</b></li> <li>b. the examiner is not satisfied that the vehicle or noise emitted is as specified in the report <b>or</b></li> <li>c. the vehicle exhaust system has been modified as permitted (when judged against the evidence provided), and the evidence supplied includes a sound level reading from a “stationary” noise test.</li> </ul> <p>Using sound level meter to the manufacturer’s instructions, carry out a stationary noise check.</p> <p>Place the vehicle within the authorised test area. With the sound meter horizontal, set the microphone height so that it is at the height of the exhaust outlet or 200mm from the ground, whichever is higher at an angle of 45 degrees to the exhaust outlet in the direction which gives the greatest distance between it and the vehicle contour at a distance of 500mm from the exhaust outlet.</p> <p>With the vehicle at normal operating temperature, run the engine to replicate the original rpm as listed on the report,</p> <p>The measured sound level will be deemed acceptable if the average of three readings is no more than 2dBA above the evidence supplied.</p>	

## Record of Revision

Revision	Date	Description of Change
1	27/03/2009	
2	28/04/2009	Note added for multiple Exhaust outlets
3	24/05/2010	Add Normal IVA to the footer, amended MOI to clarify base vehicle approvals are acceptable
4	17/06/2013	Link RS1 to notes 2 & 3, RS4 to note 1 and remove numbering from note 4.

This page intentionally left blank

## 02 Emissions

**Application:** Vehicles subject to Normal requirements

Method of Inspection	Required Standard																
<p>Conversions that are not based on M1 vehicles may comply with the applicable requirements of the original base vehicle. Documentary evidence of base or incomplete vehicle approvals will be deemed acceptable.</p> <p>Vehicles are not required to have On Board Diagnostics</p> <p>Ensure the vehicle <b>as presented</b> is accompanied by satisfactory evidence to the required standard for either Light Duty or Heavy Duty Emissions</p> <p>Where evidence of compliance has been provided, subsequent modification to the exhaust system will be permitted providing</p> <ul style="list-style-type: none"> <li>• it relates to the exhaust system length after the last silencer; and</li> <li>• the emissions control device is identical to that fitted before the modification.</li> </ul> <p>In the case of <b>Wheelchair accessible vehicles</b> the modification of the exhaust system is permitted without any further test provided:</p> <ul style="list-style-type: none"> <li>• The emission control devices including particulate filters (if any) are not affected;</li> </ul> <p>And</p> <ul style="list-style-type: none"> <li>• No new evaporative test shall be required on the modified vehicle on condition that the evaporative control devices are kept as fitted by</li> </ul>	<p>1. The vehicle <b>as presented</b> must be accompanied by satisfactory evidence of compliance with the required standard for “Emissions” (See Tables 1 &amp; 2).</p> <p>Table 1</p> <table border="1" data-bbox="1167 616 2123 911"> <thead> <tr> <th colspan="4" data-bbox="1167 616 2123 667">Heavy Duty Emissions</th> </tr> <tr> <th data-bbox="1167 667 1447 735">Manufactured Date</th> <th data-bbox="1447 667 1671 735">Directive Requirement</th> <th data-bbox="1671 667 1879 735">As amended by</th> <th data-bbox="1879 667 2123 735"></th> </tr> </thead> <tbody> <tr> <td data-bbox="1167 735 1447 804">Engines, before 1<sup>st</sup> October 2009</td> <td data-bbox="1447 735 1671 804">88/77/EEC</td> <td data-bbox="1671 735 1879 804">2001/27/EC,</td> <td data-bbox="1879 735 2123 804">Row B1 Limits apply (Euro IV)</td> </tr> <tr> <td data-bbox="1167 804 1447 911">Engines, on or after 1<sup>st</sup> October 2009</td> <td data-bbox="1447 804 1671 911">88/77/EEC</td> <td data-bbox="1671 804 1879 911">99/66/EC,</td> <td data-bbox="1879 804 2123 911">Row B2 Limits apply (Euro V)</td> </tr> </tbody> </table> <p>2. The exhaust must not emit excessive smoke or vapour of any colour to an extent likely to obscure the vision of other road users</p>	Heavy Duty Emissions				Manufactured Date	Directive Requirement	As amended by		Engines, before 1 <sup>st</sup> October 2009	88/77/EEC	2001/27/EC,	Row B1 Limits apply (Euro IV)	Engines, on or after 1 <sup>st</sup> October 2009	88/77/EEC	99/66/EC,	Row B2 Limits apply (Euro V)
Heavy Duty Emissions																	
Manufactured Date	Directive Requirement	As amended by															
Engines, before 1 <sup>st</sup> October 2009	88/77/EEC	2001/27/EC,	Row B1 Limits apply (Euro IV)														
Engines, on or after 1 <sup>st</sup> October 2009	88/77/EEC	99/66/EC,	Row B2 Limits apply (Euro V)														

Method of Inspection	Required Standard
<p>the manufacturer of the base vehicle.</p> <p>In the case of <b>Armoured vehicles</b> exemption from any requirement of this section is permitted if it can be demonstrated to the satisfaction of the Approval Authority that it is impossible for the vehicle to comply due to its special purpose.</p> <p>In the case of <b>Range Extender Hybrid</b> vehicles an internal combustion engine must be supported with documentary evidence of compliance with UNECE Regulation 83 or the equivalent EU Regulation</p>	

Table 2

Section In Manual	Date of Vehicle Manufacture	European Standard (EC or ECE equivalent)	Comparable Non-European Standards				Notes
			United States	Canada	Japan	Australia	
Exhaust Emissions (Euro-2)	01/01/1997 (passenger cars – Note 10)  (See Notes for definitions of all below)	Directive 70/220/EEC as amended by 94/12/EC annex 1, para. 5. or ECE R. 83.02, para. 5. (applies only to passenger cars)	-----	-----	-----	ADR 79/00 Petrol & Diesel	“Reference Mass” has the same meaning as in Directive 70/220/EEC as amended by Directive 96/69.  “Class I vehicle” means a goods vehicle (N1) which has a reference mass not exceeding 1305kg  “Class II vehicle” means a goods vehicle (N1) which has a reference mass exceeding 1305kg but not exceeding 1760kg
	01/10/1997 (Class I)	96/69/EC annex 1, para. 5. or ECE R. 83.03, para. 5. (Note 16)	-----	-----	-----	“	“Class III vehicle” means a goods vehicle which has a reference mass exceeding 1760kg
	01/10/1998 (Category M1 other than passenger cars, Class II & Class III)	“	-----	-----	-----	“	
	01/10/1999 (LPG & CNG)	98/77/EC annex 1, para. 5, or ECE R. 83.04, para. 5.	-----	-----	-----	“	

Section In Manual	Date of Vehicle Manufacture	European Standard (EC or ECE equivalent)	Comparable Non-European Standards				Notes
			United States	Canada	Japan	Australia	
Exhaust Emissions (Euro-3)	01/01/2001 (Passenger cars & Class I)	1/ 98/69/EC Annex 1, para. 5. (Phase 1 (level A) limits) . On-Board Diagnostic systems are not required				ADR 79/01	<p>“Diesel passenger vehicle” means a vehicle of category M1 the maximum mass of which exceeds 2000kg, fitted with a compression ignition engine, and which is:</p> <ul style="list-style-type: none"> <li>• constructed or adapted to carry more than 6occupants inc. the driver, or</li> <li>• an off road vehicle as defined in Annex II to the 2007 Directive.</li> </ul> <p>“Class I vehicle” means a goods vehicle (N1) which has a reference mass not exceeding 1305kg</p> <p>“Class II vehicle” means a goods vehicle (N1) which has a reference mass exceeding 1305kg but not exceeding 1760kg</p> <p>“Class III vehicle” means a goods vehicle which has a reference mass exceeding 1760kg</p>
	01/01/2002 (Category M1 other than passenger cars, Class II & Class III)	“					
	01/01/2003 (until this date a diesel passenger vehicle is treated as a vehicle of category N1)	“					
Exhaust Emissions (Euro-4)	01/01/2006 (Passenger cars & Class I)					ADR 79/02 Petrol & Diesel	
	01/01/2007 (Category M1 other than passenger cars, Class II & Class III)	98/69/EC, annex 1, para. 5, (Phase 2 (level B) limits) . On-Board Diagnostic systems are not required					
Exhaust Emissions (Euro 5)	01/01/2012 (Category M1)	Regulation EC715/2007 as amended by EC692/2008, annex 1, table 1, On-Board Diagnostic					

**Emissions 02**

Normal IVA



<p>Exhaust Emissions (Euro 6)</p>	<p>01/09/2016 (Category M1)</p>	<p>systems are not required Regulation EC715/2007 as amended by EC692/2008, annex 1, table 2, On-Board Diagnostic systems are not required</p>					
-----------------------------------	---------------------------------	--	--	--	--	--	--

**Note:** Class I, II and III are for Goods vehicles but may be considered for Special purpose Vehicles if derived from an N category vehicle

## Record of Revision

Revision	Date	Description of Change
1	27/03/2009	
2	28/04/2009	RS 2 added
3	24/05/2010	Add Normal IVA to the footer, Amended MOI to align with RVAR 2009, add reference to ADR 79/02
4	31/10/2011	Add Euro 5 and Euro 6 Requirements
5	29/04/2012	Insert Table
6	03/10/2016	Add paragraph to MOI for Range Extender Hybrids. Add Normal IVA to footer.

## 09 Braking

**Application:** Vehicles subject to Normal requirements

Method of Inspection	Required Standard
<p>Ensure the vehicle <b>as presented</b> is accompanied by satisfactory evidence to the required standard</p> <p><b>Conversions that are not based on M1 vehicles may comply with the applicable requirements of the original base vehicle. Documentary evidence of base or incomplete vehicle approvals will be deemed acceptable provided the maximum mass of the original approvals has not been exceeded. Approval evidence is not invalidated by repositioning brake cables or pipework.</b></p> <p>In addition to having evidence that complies to the requirements of this section a <b>Disabled person's vehicle or WAV</b> that has additional or modified operating controls is subject to all of the relevant basic requirements (09) Further more where any modifications effect the original <b>service</b> brake system such that the original evidence is compromised the applicant must get further evidence of compliance from VCA.</p> <p>Where the vehicle is equipped with ABS the vehicle must be driven and the operation (modulation) of the ABS system assessed under braking to indicate satisfactory operation of the system. NB This check is not necessary if the ABS warning lamp illuminates during a speedometer check indicating that the sensors are detecting unusual wheel speeds/operation. Where this criteria is not met the evidence does not satisfy the requirements in relation to the vehicle <b>as presented</b>.</p>	<p>1. The vehicle <b>as presented</b> must be accompanied by satisfactory evidence of compliance with the required standard for “ Braking “</p>

## Record of Revision

Revision	Date	Description of Change
1	27/03/2009	
2	24/05/2010	Add Normal IVA to the footer, Amended MOI to align with RVAR 2009 and deleted note 2
3	17/06/2013	Remove the word note

## 13A Anti – Theft / Immobiliser

**Application:** Vehicles subject to Normal requirements

Method of Inspection	Required Standard
<p>An immobiliser is an electronic device intended to prevent the driving away of a vehicle powered by its own engine.</p> <p>Ensure that the vehicle <b>as presented</b> is accompanied by documentary evidence of compliance for a category 1 or 2 installation. Not required for vehicles first registered in Japan after 01/07/2006 presented with Japanese de-reg documentation.</p> <p><b>Conversions that are not based on M1 vehicles do not need to comply if there was no theft / immobiliser requirement for the base vehicle.</b></p> <p>A “Category 2” installation refers to an immobiliser only. A “Category 1” installation refers to an immobiliser and an alarm.</p> <p>Evidence of compliance can be one of the following:</p> <ul style="list-style-type: none"> <li>• Documentary evidence from a test laboratory</li> <li>• Documentary evidence from the vehicle manufacturer (in the case of a mass produced vehicle)</li> <li>• An original certificate of installation from a Mobile Electronics and Security Federation (MESF) accredited installer</li> <li>• An original installation report from a Thatcham Recognised Installer (TRI)</li> </ul>	<ol style="list-style-type: none"> <li>1. The vehicle <b>as presented</b> must be accompanied by evidence of compliance for an Immobiliser</li> </ol>

## Anti – Theft / Immobiliser 13A

## Record of Revision

Revision	Date	Description of Change
1	27/03/2009	
2	24/05/2010	Add Normal IVA to the footer, amended MOI to align with RVAR 2009
3	18/10/2010	Add Thatcham Recognised Installer installation report to list of acceptable evidence
4	09/05/2011	Remove VSIB from the list of acceptable evidence
5	17/06/2013	Remove the word note
6	03/10/2016	Expand MOI para 2. Add Normal IVA to footer.

## Anti – Theft / Immobiliser 13A

## 13B Anti – Theft / Alarm

**Application:** Vehicles subject to Normal requirements (optional fitment)

Method of Inspection	Required Standard
<p>Ensure that any Alarm and optional Panic Alarm which does not form part of the vehicle alarm system is accompanied by satisfactory documentary evidence of compliance</p> <p><b>Conversions that are not based on M1 vehicles do not need to comply if there was no theft / alarm requirement for the base vehicle.</b></p> <p>A “Category 1” installation refers to an immobiliser and an alarm.</p> <p>Panic Alarm means a device which enables a person to use an alarm, installed on the vehicle, to summon assistance in an emergency</p> <p>Evidence of compliance can be one of the following:</p> <ul style="list-style-type: none"> <li>• Documentary evidence from a test laboratory</li> <li>• Documentary evidence from the vehicle manufacturer (in the case of a mass produced vehicle)</li> <li>• An original certificate of installation from a Mobile Electronics and Security Federation (MESF) accredited installer</li> <li>• An original installation report from a Thatcham Recognised Installer (TRI)</li> </ul>	<ol style="list-style-type: none"> <li>1. The vehicle <b>as presented</b> must be accompanied by evidence of compliance where an alarm is fitted</li> <li>2. The vehicle <b>as presented</b> must be accompanied by evidence of compliance where an panic alarm is fitted</li> </ol>

## Record of Revision

Revision	Date	Description of Change
1	27/03/2009	
2	29/06/2009	Added optional fitment to application header
3	24/05/2010	Add Normal IVA to the footer , amended MOI to align with RVAR 2009
4	18/10/2010	Add Thatcham Recognised Installer installation report to list of acceptable evidence
5	09/05/2011	Remove VSIB from the list of acceptable evidence
6	17/06/2013	Remove the word note



# 14 Protective Steering

**Application:** Vehicles subject to Normal requirements

Method of Inspection	Required Standard
<p>Ensure the vehicle <b>as presented</b> is accompanied by satisfactory evidence to the required standard</p> <p>Vehicles that comply with Section 53 (Frontal Impact) of this manual are exempt from this inspection providing there is no evidence to suggest the original vehicle has been modified i.e. it is still equipped with the original steering wheel etc</p> <p>Vehicles that are derived from an N1 category vehicle with maximum mass greater than 1500kg are exempt from this inspection.</p> <p><b>Conversions that are not based on M1 vehicles may comply with the applicable requirements of the original base vehicle. Documentary evidence of base or incomplete vehicle approvals will be deemed acceptable provided the maximum mass of the original approvals has not been exceeded.</b></p> <p><b>The requirements of this item do not apply to a disabled persons' vehicle insofar as the adaptation prevents the vehicle from complying with any of the requirements of this item, except that this exemption does not apply where such adaptations can easily be removed, if necessary with the use of tools, and in which case evidence of compliance before the vehicle was adapted is required.</b></p>	<ol style="list-style-type: none"> <li data-bbox="1173 456 2051 549">1. The vehicle <b>as presented</b> must be accompanied by satisfactory evidence of compliance with the required standard for "protective steering".</li> </ol>

## Record of Revision

Revision	Date	Description of Change
1	27/03/2009	
2	24/05/2010	Add Normal IVA to the footer, Added statement to align with RVAR 2009

# 19 Seat Belt Anchorages

**Application:** Vehicles subject to Normal requirements

Method of Inspection	Required Standard
<p>Ensure the vehicle <b>as presented</b> is accompanied by satisfactory evidence to the required standard</p> <p>Seating positions in special purpose vehicles that are for use when the vehicle is stationary do not need to comply with anchorage requirements. Seats that are for use only when stationary must be identified by means of a pictogram or a sign with appropriate text.</p> <p>In the case of wheelchair accessible, a disabled person's vehicle adapted by a person other than the base vehicle manufacturer, any seat belt anchorage points fitted by that person may comply instead with Basic IVA requirements</p> <p>The IVA seat belt anchorage compliance and installation declarations are now available on line at <a href="http://www.businesslink.gov.uk">www.businesslink.gov.uk</a> (Forms 19a &amp; 19b)</p> <p><b>Note 1:</b> If attached to a thin metal floor, adequate support to spread the load of the anchorage is required, e.g. spreader plates of at least 75mm x 75mm x 4mm mild steel fitted under the floor, of the legs closest to the rear of the vehicle and between the leg and the top of the floor surface for the leg closest to the front of the vehicle</p>	<ol style="list-style-type: none"> <li>1. The vehicle <b>as presented</b> must be accompanied by satisfactory evidence of compliance with the required standard for "Seat Belt Anchorages".</li> <li>2. For vehicles with seat belts fitted to secure passengers in Side Facing Seats, the belt anchorage points, including the seat anchorage for belts mounted directly to a seat, must be securely attached to the vehicle structure, or other obvious suitable load bearing parts of the vehicle (see <b>Note 1</b>)</li> </ol>

## Seat Belt Anchorages 19

## Record of Revision

Revision	Date	Description of Change
1	27/03/2009	
2	03/052010	Add Normal IVA to the footer, amended MOI to align with RVAR 2009
3	18/04/2011	Clarification of satisfactory evidence for seatbelt anchorage in converted or modified vehicles
4	31/10/2011	Revise wording Mol paragraph 3, add new paragraph 4 and remove annexes – now available on line
5	30/09/2012	Insert new note 1 and new RS2

## 39 Fuel Consumption / CO2 Emissions

**Application:** Vehicles subject to Normal requirements (Vehicles approved to Heavy Duty Emissions are exempt)

Method of Inspection	Required Standard
<p>Ensure the vehicle <b>as presented</b> is accompanied by satisfactory evidence to the required standard</p> <p>Does not apply where the applicant accepts a CO2 figure determined by the Secretary of State.</p> <p>Subsequent modification of the exhaust system is permitted providing</p> <ul style="list-style-type: none"> <li>• it is downstream of any emissions control device</li> <li>• the emissions control device is identical to that fitted before the modification.</li> </ul>	<ol style="list-style-type: none"> <li>1. The vehicle <b>as presented</b> must be accompanied by satisfactory evidence of compliance with the required standard for "Fuel Consumption/CO2"</li> </ol>

## Record of Revision

Revision	Date	Description of Change
1	27/03/2009	
2	24/05/2010	Add Normal IVA to the footer

## 53 Frontal Impact

**Application:** Vehicles subject to Normal requirements with a effective date from October 2003 and a total permitted mass not greater than 2500kg (All vehicles derived from an N1 category vehicle are exempt)

Method of Inspection	Required Standard
<p>Ensure the vehicle <b>as presented</b> is accompanied by satisfactory evidence to the required standard.</p> <p>Conversions that are not based on M1 vehicles may comply with the applicable requirements of the original base vehicle. Documentary evidence of base or incomplete vehicle approvals will be deemed acceptable provided the maximum mass of the original approvals has not been exceeded.</p> <p><b>Wheelchair accessible vehicles</b>, and <b>Disabled person's vehicles</b>, the vehicle is not required to comply in respect of an adaptation for a disabled person affecting the "frontal impact". Evidence of compliance of the unadapted vehicle is required.</p>	<ol style="list-style-type: none"> <li>1. The vehicle <b>as presented</b> must be accompanied by satisfactory evidence of compliance with the required standard for "Frontal Impact".</li> </ol>

## Record of Revision

Revision	Date	Description of Change
1	27/03/2009	
2	24/05/2010	Add Normal IVA to the footer, amended MOI to align with RVAR 2009



## 54 Side Impact

**Application:** Vehicles subject to Normal requirements with a effective date from October 2003 and a seat reference point no greater than 700mm from the ground

Method of Inspection	Required Standard
<p>Ensure the vehicle <b>as presented</b> is accompanied by satisfactory evidence to the required standard.</p> <p><b>Conversions that are not based on M1 vehicles may comply with the applicable requirements of the original base vehicle. Documentary evidence of base or incomplete vehicle approvals will be deemed acceptable provided the maximum mass of the original approvals has not been exceeded.</b></p> <p><b>Wheelchair accessible vehicles, and Disabled person's vehicles,</b> the vehicle is not required to comply in respect of an adaptation for a disabled person affecting the "side impact". Evidence of compliance of the unadapted vehicle is required.</p>	<ol style="list-style-type: none"> <li data-bbox="1249 491 2123 587">1. The vehicle <b>as presented</b> must be accompanied by satisfactory evidence of compliance with the required standard for "Side Impact".</li> </ol>

## Record of Revision

Revision	Date	Description of Change
1	27/03/2009	
2	24/05/2010	Add Normal IVA to the footer, amended MOI to clarify and align with RVAR 2009

## 62 Hydrogen Powered Motor Vehicles

**Application:** All Vehicles powered by hydrogen

### For the information of applicants only

This item is not inspected in the test station. Instead, all documentary evidence will be sent at time of application for processing. Technical Branch in Swansea may need to liaise with VCA or DoE NI in Northern Ireland to confirm the vehicle complies with requirements for Hydrogen powered vehicles before the test takes place.

Before a Hydrogen powered vehicle can be used on the road in Great Britain or Northern Ireland, it is necessary to apply for a permit. This is known as a Vehicle Special Order (VSO) and would be issued by:

- Vehicle Certification Agency (VCA) for Great Britain. For more details please contact them at: <http://www.dft.gov.uk/vca/other/vehicle-special-orders.asp>
- Department of Environment Northern Ireland (DoENI). For more details please contact them at: enquiries@doeni.gov.uk

VCA / DoENI are likely to require satisfactory evidence of compliance with Regulation (EC) No 79/2009 and Regulation (EU) No 406/2010 on Hydrogen powered vehicles. For more information on these, please contact VCA.

Hydrogen powered vehicles can be either internal combustion engine, with hydrogen fuel burnt in a similar way to petrol, or they can be hydrogen fuel cell, where hydrogen is converted to electricity in a chemical reaction, and the electricity powers the vehicle via an electric motor. The hydrogen can be stored (under high pressure) in compressed gas or liquefied form.

### Method of Inspection

Confirm that the vehicle is a Hydrogen powered vehicle, by noting the presence of a Hydrogen fuel tank, and in the case of hydrogen fuel cell vehicle, the fuel cell and electric motor.

For Hydrogen powered vehicles, Section 02 of this manual (Emissions) only applies in the case of vehicles subject to Light Duty Emissions (715/2007) requirements, this is generally vehicles below 2610kg 'reference mass'. Section 03A of the manual (Fuel tanks) does not apply, unless (in the case of internal combustion engined vehicles) a fuel tank designed to contain a different kind of fuel for powering the vehicle is also fitted, in which case that Section would apply.

## Hydrogen Powered Vehicles

Revision	Date	Description of Change
1	30/09/2012	
2	03/10/2016	Add Normal IVA to footer.

# Glossary of Terms

## Air Bag

A flexible bag fitted to a vehicle designed to be filled with gas under pressure in order to protect the driver or front seat passenger in the event of a collision involving the front of the vehicle.

## Blunted Edge

An edge not likely to cause injury whatever the circumstances. Under finger/thumb pressure contact is not likely to puncture the skin

## Body Plan Form / Extreme Outer Edge

The area resulting from the vertical projection of the complete body onto a horizontal surface: for the purposes of this definition “complete body” means all parts of the bodywork and chassis, including any separate wheel guards but not including running gear such as wheels, axles, suspension, brakes and steering.

'Body Plan Form' a projection of the complete body onto a horizontal surface including all bodywork but excluding wheels & suspension.

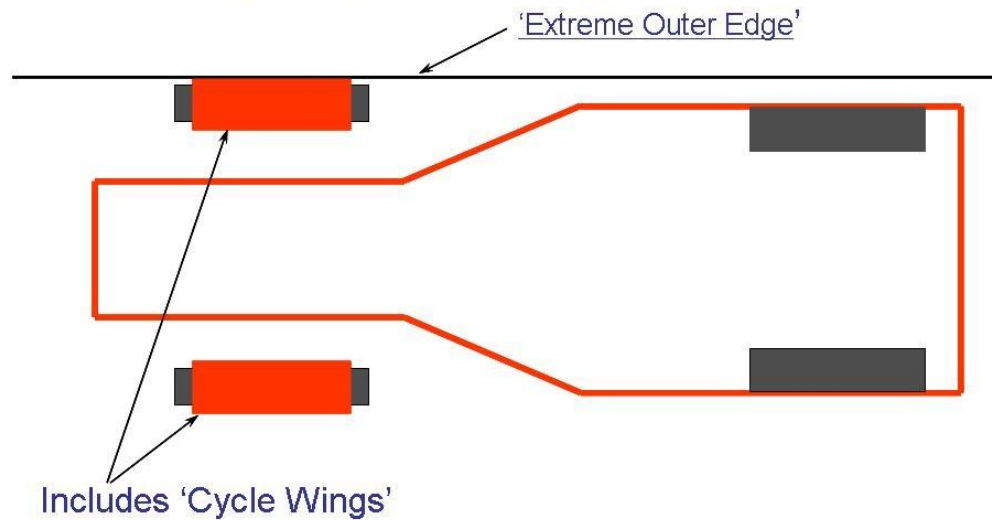

# Glossary of Terms

**Brake Efficiency**

Maximum total brake force expressed as a percentage of maximum gross weight.

**Car Derived Van**

A goods vehicle which is constructed or adapted as a derivative of a passenger vehicle and which has a maximum laden weight not exceeding 2 tonnes. The important word in this definition is 'and' as there are goods vehicles that look as if they are based on a passenger vehicle, but when the manufacturer puts a gross laden weight on the goods vehicle, which is the design weight of the vehicle plus the maximum load that it is designed to carry, and this exceeds 2 tonnes, that vehicle is no longer a car derived van. The van becomes an ordinary goods vehicle under 7.5 tonnes gross weight.

**CNG**

Compressed Natural Gas

**Convertible Car**

A vehicle where, in certain configurations, there is no rigid part of the vehicle body above the belt line with the exception of the front roof supports and/or the roll-over bars and/or the seat belt anchorage points.

**Cycle Wings**

Motorcycle type front mud wings which move in parallel with the steered wheels

**Date of Manufacture**

In the case of an Amateur Built Vehicle is, unless otherwise stated in the regulations or Inspection Manual:

- a. the date on which the vehicle is presented for examination; or
- b. a date prior to the date the vehicle is presented for examination if there is conclusive evidence the vehicle was completed and included all the parts which it needs to comply with the prescribed requirements and was in such a condition as to be acceptable to test on that date.

**Designated Seating Position**

A position where there is a seat designated for normal use while the vehicle is travelling on the road.

**Disabled Person's Belt**

A seat belt which has been specifically designed or adapted for use by an adult or young person suffering from some physical defect or disability and which is intended for use solely by such a person.

### **Extreme Outer Edge**

In relation to the side of a vehicle, the vertical plane parallel with the longitudinal axis of the vehicle and coinciding with its lateral outer edge, disregard the protection of

- distortion of any tyre due to the weight of the vehicle
- connections for tyre pressure gauges
- anti-skid devices mounted on the wheels
- rear view mirrors
- lamps and reflectors
- custom seals and devices for securing and protecting such seals
- special equipment
- in respect of Section 16 (Exterior Projections) only: windows, handles, hinges, push buttons and fuel tank filler caps.

### **Gullwing door**

A door that hinges from top of the door aperture.

### **Hard Parts**

Parts made of a material of hardness exceeding 50 shore.

### **Harness Belt**

Means an adult belt which is a harness belt comprising a lap belt and shoulder straps.

### **Ignition Switch**

A key operated switch normally used to start the engine.

**Impossible to Comply**

'Impossible to comply' is the wording taken straight from the Directive and should be taken to mean that is either 'impossible' for the item to comply by virtue of the fact that any modification might negate its own stand alone approval or that in certain instances, such as lifts for stretchers/wheelchairs etc., it would be considered too onerous to expect the presenter to modify the item in order to comply.

**In Running Order**

In relation to the vehicle weight, means

All fluids (such as oils and engine coolant) necessary for the vehicle to be driven, full fuel tank, a spare wheel and tool kit carrying a driver of 75kg but no other passengers or load.

**Insecure**

A component or its fixing is, due to its design or a construction feature, not completely attached to the vehicle structure or to another associated component as intended.

**Kerbside Weight**

For the purpose of this manual only:

The weight of the vehicle with no driver or passengers, a full fuel tank, an adequate supply of the necessary oils, water, fluids etc and no load other than tools and equipment normally carried.

**Lambda**

The ratio by mass of air to petrol vapour in the mixture entering the combustion chamber, divided by 14.7.

**Lap Belt**

A seat belt which passes across the front of the wearer's pelvic region and which is designed for use by an adult.

**Lateral Brake Distribution**

In relation to an axle, means the ratio (expressed as a percentage) of the lower to the higher of the braking forces transmitted by the tyres to the road surface for two wheels, on opposite sides of the vehicle on the same axle.

**Longitudinal Plane**

A vertical plane parallel to the longitudinal axis of the vehicle.

**LPG**

Liquefied Petroleum Gas.



**Major Manufacturer**

A vehicle manufacturer that produces vehicles approved to EC Whole Vehicle Type Approval standards, comparable non-European or other acceptable standards.

**Manufacturer's Plate**

A piece of durable material e.g. metal or plastic that is likely to last the life of the vehicle and which is permanently marked with the required markings.

**Mass produced Vehicle**

For the purpose of this manual only:

A vehicle as originally manufactured in numbers greater than 300 that has been subject to no more than minor modification or alteration since manufacture, that is produced by a recognised **Major Manufacturer** such that the vehicle referred to would be of a type expected to be seen by the public in a showroom supported by a major world renown manufacturer. IE it would meet the "reasonable test".

**Matched Pair**

For the purpose of this manual only:

Lamps fitted to the vehicle must be of the same brightness, intensity, colour, shape, height, position and beam pattern.

**Non Rigid Material**

A material which has a hardness of less than 50 shore A. For the purposes of this examination it will be deemed to be a material which is capable of depression under thumb pressure and when deformed retains a degree of protection against contact with any structure which it is covering and when released returns to its original form.

**Orientation**

For the purpose of this manual only:

Headlamps require to be fitted as they are intended i.e. Top to Top etc. Some lamps are fitted at other angles to combat the cut off requirement for headlamp aim.

**Power Braking**

A system that requires the use of stored energy to operate.

**Production Vehicle**

A vehicle of a make, model and type mass produced by the vehicle manufacturer.

**Radius**

Refers to the external radius of curvature.

**Range Extender Hybrid**

An electric vehicle which, as its name suggests, is supported by a 'stationary engine' driving a generator to supply electricity to the battery for the propulsion of the vehicle and thus extend its driving range.

**Reciprocally incorporated lamps**

Devices having separate light sources or a single light source operating under different conditions (for example, optical, mechanical, electrical differences), totally or partially common apparent surfaces in the direction of the reference axis and a common lamp body.

**Rotary Engine**

An engine in which the torque is provided by means of one or more rotors and not by any reciprocating pistons and which is deemed to be a four stroke engine.

**Run Lock**

A system which enables the vehicle's engine to continue running with the ignition key removed (in order to maintain battery charge) and the anti-theft system activated.

**Seat Displacement Device**

A device to permit forward tipping of a seat or the back rest to fold down.

**Servo Assisted**

A system where the muscular energy of the driver is supplemented by another energy source.

**Side Screen**

An item of glazing wholly or partly on either side of the driver's seat that does not slide or move relative to the vehicle or any of its parts (including glazing) in a manner likely to cause abrasion to any glazing surface

**Suicide Door**

A door that hinges from the rear of the door aperture.

**Temporary-use spare tyre**

Means a tyre different from a tyre intended to be fitted to any vehicle for normal driving conditions; but intended only for temporary use under restricted driving condition

**Wheelchair accessible vehicle (WAV)**

A vehicle constructed or converted specifically so that it can accommodate one or more person(s) seated in their wheelchair(s) when travelling on the road.

## Record of Revision

Revision	Date	Description of Change
1	27/03/2009	
2	09/04/2009	External Surface has been replaced with Extreme Outer Edge
3	24/05/2010	Amend Running order definition to incorporate TSE IVA 000M1 GL 001, add definition for gullwing and suicide door
4	29/04/2012	Insert definitions of a Car Derived Van and Reciprocally Incorporated Lamps and amend definition of Major Manufacturer
5	17/06/2013	Insert 4 definitions: Impossible to comply, Non rigid material, Run Lock and WAV
6	03/10/2016	Insert definition of Range Extender Hybrid